



## DIGITAL MIXING CONSOLE

**TF5**

**TF3**

**TF1**

### V3.5 Quick Guide

Thank you for choosing a Yamaha TF5/TF3/TF1 Digital Mixing Console. To take full advantage of the superior features and performance offered by your TF-series console, and to enjoy years of trouble-free use, please read this document carefully before operating your console.

# Contents

<b>1. Precautions .....</b>	<b>5</b>
<b>2. Introduction .....</b>	<b>7</b>
2-1 Intended user.....	7
2-2 Intended usage.....	7
2-3 Included items .....	7
2-4 Documentation.....	7
2-5 Updating the product's software and firmware .....	7
2-6 Nomenclature used in this document.....	7
<b>3. Panels.....</b>	<b>8</b>
3-1 Top panel.....	8
3-2 Rear panel .....	9
<b>4. Workflow Overview .....</b>	<b>10</b>
<b>5. Connections .....</b>	<b>12</b>
<b>6. Controls and functions.....</b>	<b>13</b>
6-1 Channel Strip section.....	13
6-2 ST IN (Stereo Input) section.....	13
6-3 FX section .....	14
6-4 USER DEFINED KEYS section.....	14
6-5 MUTE section.....	14
6-6 METER section.....	14
6-7 PHONES section.....	14
6-8 FADER BANK section.....	15
6-9 TAP section.....	15
6-10 SENDS ON FADER section.....	15
6-11 Display section .....	15
6-12 STEREO/MASTER section .....	17
6-13 iPad connector.....	17
6-14 USB connector.....	17
<b>7. Displaying the configuration screens.....</b>	<b>18</b>
<b>8. Setup.....</b>	<b>22</b>
8-1 Setting the internal clock .....	22
8-2 Initialization (factory reset).....	22
8-3 Attaching the optional Rack Mount Kit (RK5014) (TF1 only) .....	23
8-4 Installing an NY card .....	24
<b>9. Troubleshooting .....</b>	<b>25</b>
<b>10. Specifications .....</b>	<b>26</b>

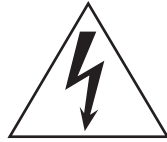

## CAUTION

RISK OF ELECTRIC SHOCK  
DO NOT OPEN



**CAUTION:**  
**TO REDUCE THE RISK OF ELECTRIC SHOCK, DO NOT REMOVE COVER (OR BACK).**  
**NO USER-SERVICEABLE PARTS INSIDE.**  
**REFER SERVICING TO QUALIFIED SERVICE PERSONNEL.**

The above warning is located on the rear of the unit.  
L'avertissement ci-dessus est situé sur l'arrière de l'unité.

## Explanation of Graphical Symbols Explication des symboles



The lightning flash with arrowhead symbol within an equilateral triangle is intended to alert the user to the presence of uninsulated "dangerous voltage" within the product's enclosure that may be of sufficient magnitude to constitute a risk of electric shock to persons.

L'éclair avec une flèche à l'intérieur d'un triangle équilatéral est destiné à attirer l'attention de l'utilisateur sur la présence d'une « tension dangereuse » non isolée à l'intérieur de l'appareil, pouvant être suffisamment élevée pour constituer un risque d'électrocution.



The exclamation point within an equilateral triangle is intended to alert the user to the presence of important operating and maintenance (servicing) instructions in the literature accompanying the product.

Le point d'exclamation à l'intérieur d'un triangle équilatéral est destiné à attirer l'attention de l'utilisateur sur la présence d'instructions importantes sur l'emploi ou la maintenance (réparation) de l'appareil dans la documentation fournie.

## IMPORTANT SAFETY INSTRUCTIONS

- 1 Read these instructions.
- 2 Keep these instructions.
- 3 Heed all warnings.
- 4 Follow all instructions.
- 5 Do not use this apparatus near water.
- 6 Clean only with dry cloth.
- 7 Do not block any ventilation openings. Install in accordance with the manufacturer's instructions.
- 8 Do not install near any heat sources such as radiators, heat registers, stoves, or other apparatus (including amplifiers) that produce heat.
- 9 Do not defeat the safety purpose of the polarized or grounding-type plug. A polarized plug has two blades with one wider than the other. A grounding type plug has two blades and a third grounding prong. The wide blade or the third prong are provided for your safety. If the provided plug does not fit into your outlet, consult an electrician for replacement of the obsolete outlet.
- 10 Protect the power cord from being walked on or pinched particularly at plugs, convenience receptacles, and the point where they exit from the apparatus.
- 11 Only use attachments/accessories specified by the manufacturer.
- 12 Use only with the cart, stand, tripod, bracket, or table specified by the manufacturer, or sold with the apparatus. When a cart is used, use caution when moving the cart/apparatus combination to avoid injury from tip-over.
- 13 Unplug this apparatus during lightning storms or when unused for long periods of time.
- 14 Refer all servicing to qualified service personnel. Servicing is required when the apparatus has been damaged in any way, such as power-supply cord or plug is damaged, liquid has been spilled or objects have fallen into the apparatus, the apparatus has been exposed to rain or moisture, does not operate normally, or has been dropped.



### WARNING

TO REDUCE THE RISK OF FIRE OR ELECTRIC SHOCK, DO NOT EXPOSE THIS APPARATUS TO RAIN OR MOISTURE.

(UL60065\_03)

## PRÉCAUTIONS CONCERNANT LA SÉCURITÉ

- 1 Lire ces instructions.
- 2 Conserver ces instructions.
- 3 Tenir compte de tous les avertissements.
- 4 Suivre toutes les instructions.
- 5 Ne pas utiliser ce produit à proximité d'eau.
- 6 Nettoyer uniquement avec un chiffon propre et sec.
- 7 Ne pas bloquer les orifices de ventilation. Installer l'appareil conformément aux instructions du fabricant.
- 8 Ne pas installer l'appareil à proximité d'une source de chaleur comme un radiateur, une bouche de chaleur, un poêle ou tout autre appareil (y compris un amplificateur) produisant de la chaleur.
- 9 Ne pas modifier le système de sécurité de la fiche polarisée ou de la fiche de terre. Une fiche polarisée dispose de deux broches dont une est plus large que l'autre. Une fiche de terre dispose de deux broches et d'une troisième pour le raccordement à la terre. Cette broche plus large ou cette troisième broche est destinée à assurer la sécurité de l'utilisateur. Si la fiche équipant l'appareil n'est pas compatible avec les prises de courant disponibles, faire remplacer les prises par un électricien.
- 10 Acheminer les cordons d'alimentation de sorte qu'ils ne soient pas piétinés ni coincés, en faisant tout spécialement attention aux fiches, prises de courant et au point de sortie de l'appareil.
- 11 Utiliser exclusivement les fixations et accessoires spécifiés par le fabricant.
- 12 Utiliser exclusivement le chariot, le stand, le trépied, le support ou la table recommandés par le fabricant ou vendus avec cet appareil. Si l'appareil est posé sur un chariot, déplacer le chariot avec précaution pour éviter tout risque de chute et de blessure.
- 13 Débrancher l'appareil en cas d'orage ou lorsqu'il doit rester hors service pendant une période prolongée.
- 14 Confier toute réparation à un personnel qualifié. Faire réparer l'appareil s'il a subi tout dommage, par exemple si la fiche ou le cordon d'alimentation est endommagé, si du liquide a coulé ou des objets sont tombés à l'intérieur de l'appareil, si l'appareil a été exposé à la pluie ou à de l'humidité, si l'appareil ne fonctionne pas normalement ou est tombé.



### AVERTISSEMENT

POUR RÉDUIRE LES RISQUES D'INCENDIE OU DE DÉCHARGE ÉLECTRIQUE, N'EXPOSEZ PAS CET APPAREIL À LA PLUIE OU À L'HUMIDITÉ.

(UL60065\_03)

## FCC INFORMATION (U.S.A.)

### 1. IMPORTANT NOTICE: DO NOT MODIFY THIS UNIT!

This product, when installed as indicated in the instructions contained in this manual, meets FCC requirements. Modifications not expressly approved by Yamaha may void your authority, granted by the FCC, to use the product.

**2. IMPORTANT:** When connecting this product to accessories and/or another product use only high quality shielded cables. Cable/s supplied with this product MUST be used. Follow all installation instructions. Failure to follow instructions could void your FCC authorization to use this product in the USA.

**3. NOTE:** This product has been tested and found to comply with the requirements listed in FCC Regulations, Part 15 for Class "B" digital devices. Compliance with these requirements provides a reasonable level of assurance that your use of this product in a residential environment will not result in harmful interference with other electronic devices. This equipment generates/uses radio frequencies and, if not installed and used according to the instructions found in the users manual, may cause interference harmful to the operation of other electronic devices. Compliance with FCC regulations does not guarantee that interference will not occur in all installations. If this product is found to be the source of interference, which can be determined by turning the unit "OFF" and "ON", please try to eliminate the problem by using one of the following measures:

Relocate either this product or the device that is being affected by the interference.

Utilize power outlets that are on different branch (circuit breaker or fuse) circuits or install AC line filter/s.

In the case of radio or TV interference, relocate/reorient the antenna. If the antenna lead-in is 300 ohm ribbon lead, change the lead-in to co-axial type cable.

If these corrective measures do not produce satisfactory results, please contact the local retailer authorized to distribute this type of product. If you can not locate the appropriate retailer, please contact Yamaha Corporation of America, Electronic Service Division, 6600 Orangethorpe Ave, Buena Park, CA90620

The above statements apply ONLY to those products distributed by Yamaha Corporation of America or its subsidiaries.

\* This applies only to products distributed by YAMAHA CORPORATION OF AMERICA.

(class B)

### ADVARSEL!

Lithiumbatteri—Eksplosionsfare ved fejlagtig håndtering. Udskiftning må kun ske med batteri af samme fabrikat og type. Levér det brugte batteri tilbage til leverandoren.

### VARNING

Explosionsfara vid felaktigt batteribyte. Använd samma batterityp eller en ekvivalent typ som rekommenderas av apparattillverkaren. Kassera använt batteri enligt fabrikantens instruktion.

### VAROITUS

Paristo voi räjähtää, jos se on virheellisesti asennettu. Vaihda paristo ainoastaan laitevalmistajan suosittelemaan tyyppiin. Hävitä käytetty paristo valmistajan ohjeiden mukaisesti.

(lithium caution)

## NEDERLAND / THE NETHERLANDS

- Dit apparaat bevat een lithium batterij voor geheugen back-up.
- This apparatus contains a lithium battery for memory back-up.
- Raadpleeg uw leverancier over de verwijdering van de batterij op het moment dat u het apparaat aan het einde van de levensduur of gelieve dan contact op te nemen met de vertegenwoordiging van Yamaha in uw land.
- For the removal of the battery at the moment of the disposal at the end of life please consult your retailer or Yamaha representative office in your country.
- Gooi de batterij niet weg, maar lever hem in als KCA.
- Do not throw away the battery. Instead, hand it in as small chemical waste.

(lithium disposal)

This product contains a battery that contains perchlorate material.

Perchlorate Material—special handling may apply, See [www.dtsc.ca.gov/hazardouswaste/perchlorate](http://www.dtsc.ca.gov/hazardouswaste/perchlorate).

\* This applies only to products distributed by YAMAHA CORPORATION OF AMERICA.

(Perchlorate)

In Finland: Laite on liitettävä suojamaadoituskoskettimilla varustettuun pistorasiaan.

In Norway: Apparatet må tilkoples jordet stikkontakt.

In Sweden: Apparatens skall anslutas till jordat uttag.

(class I hokuo)

## COMPLIANCE INFORMATION STATEMENT (DECLARATION OF CONFORMITY PROCEDURE)

Responsible Party : Yamaha Corporation of America  
Address : 6600 Orangethorpe Ave., Buena Park, Calif. 90620

Telephone : 714-522-9011

Type of Equipment : Digital Mixing Console

Model Name : TF5/TF3/TF1

This device complies with Part 15 of the FCC Rules. Operation is subject to the following two conditions:  
1) this device may not cause harmful interference, and  
2) this device must accept any interference received including interference that may cause undesired operation.

See user manual instructions if interference to radio reception is suspected.

\* This applies only to products distributed by YAMAHA CORPORATION OF AMERICA

(FCC DoC)

이 기기는 가정용(B급) 전자파적합기기로서 주로 가정에서 사용하는 것을 목적으로 하며, 모든 지역에서 사용할 수 있습니다.

(class b korea)

## PLEASE READ CAREFULLY BEFORE PROCEEDING

Please keep this manual in a safe place for future reference.



**Always follow the basic precautions listed below to avoid the possibility of serious injury or even death from electrical shock, short-circuiting, damages, fire or other hazards. These precautions include, but are not limited to, the following:**

### Power supply/power cord

- Do not place the power cord near heat sources such as heaters or radiators, and do not excessively bend or otherwise damage the cord, place heavy objects on it, or place it in a position where anyone could walk on, trip over, or roll anything over it.
- Only use the voltage specified as correct for the device. The required voltage is printed on the name plate of the device.
- Use the specified adaptor (page 7) only. Using the wrong adaptor can result in damage to the device or overheating.
- Use only the supplied power cord/plug.  
If you intend to use the device in an area other than in the one you purchased, the included power cord may not be compatible. Please check with your Yamaha dealer.
- Check the electric plug periodically and remove any dirt or dust which may have accumulated on it.
- When setting up the device, make sure that the AC outlet you are using is easily accessible. If some trouble or malfunction occurs, immediately turn off the power switch and disconnect the plug from the outlet. Even when the power switch is turned off, as long as the power cord is not unplugged from the wall AC outlet, the device will not be disconnected from the power source.
- Remove the electric plug from the outlet when the device is not to be used for extended periods of time, or during electrical storms.
- Be sure to connect to an appropriate outlet with a protective grounding connection.

### Do not open

- This device contains no user-serviceable parts. Do not open the device or attempt to disassemble the internal parts or modify them in any way. If it should appear to be malfunctioning, discontinue use immediately and have it inspected by qualified Yamaha service personnel.

### Water warning

- Do not expose the device to rain, use it near water or in damp or wet conditions, or place on it any containers (such as vases, bottles or glasses) containing liquids which might spill into any openings. If any liquid such as water seeps into the device, turn off the power immediately and unplug the power cord from the AC outlet. Then have the device inspected by qualified Yamaha service personnel.
- Never insert or remove an electric plug with wet hands.

### Hearing loss

- Avoid setting all equalizer controls and faders to their maximum. Depending on the condition of the connected devices, doing so may result in feedback that can cause hearing loss and damage the speakers.
- Do not use headphones for a long period of time at a high or uncomfortable volume level, since this can cause permanent hearing loss. If you experience any hearing loss or ringing in the ears, consult a physician.
- When turning on the AC power in your audio system, always turn on the power amplifier LAST, to avoid hearing loss and speaker damage. When turning the power off, the power amplifier should be turned off FIRST for the same reason.

### Fire warning

- Do not place any burning items or open flames near the device, since they may cause a fire.

### If you notice any abnormality

- If any of the following problems occur, immediately turn off the power switch and disconnect the electric plug from the outlet.
  - The power cord or plug becomes frayed or damaged.
  - Unusual smells or smoke are emitted.
  - Some object has been dropped into the device.
  - There is a sudden loss of sound during use of the device.
  - Cracks or other visible damage appear on the device.Then have the device inspected or repaired by qualified Yamaha service personnel.
- If this device should be dropped or damaged, immediately turn off the power switch, disconnect the electric plug from the outlet, and have the device inspected by qualified Yamaha service personnel.



**Always follow the basic precautions listed below to avoid the possibility of physical injury to you or others, or damage to the device or other property. These precautions include, but are not limited to, the following:**

### Power supply/power cord

- When removing the electric plug from the device or an outlet, always hold the plug itself and not the cord. Pulling by the cord can damage it.

### Location

- Do not place the device in an unstable position where it might accidentally fall over and cause injuries.
- Do not block the vents. This device has ventilation holes at the top/front/rear to prevent the internal temperature from becoming too high. In particular, do not place the device on its side or upside down. Inadequate ventilation can result in overheating, possibly causing damage to the device(s), or even fire.
- Do not place the device in a location where it may come into contact with corrosive gases or salt air. Doing so may result in malfunction.
- Before moving the device, remove all connected cables.
- If the device is mounted in an EIA standard rack, carefully read the section "Precautions when rackmounting" on page 23. Inadequate ventilation can result in overheating, possibly causing damage to the device(s), malfunction, or even fire.

### Connections

- Before connecting the device to other devices, turn off the power for all devices. Also, before turning the power of all devices on or off, make sure that all volume levels are set to the minimum. Failing to do so may result in electric shock, hearing loss, or equipment damage.

### Maintenance

- Remove the power plug from the AC outlet when cleaning the device.

### Handling caution

- Do not insert your fingers or hands in any gaps or openings on the device (vents, panel, etc.).
- Avoid inserting or dropping foreign objects (paper, plastic, metal, etc.) into any gaps or openings on the device (vents, panel, etc.) If this happens, immediately turn off the power, unplug the power cord from the AC outlet, and have the device inspected by qualified Yamaha service personnel.
- Do not rest your weight on the device or place heavy objects on it, and avoid use excessive force on the buttons, switches or connectors to prevent injuries.
- Avoid pulling the connected cables to prevent injuries.

## Precautions

### Backup battery

- Do not replace the backup battery by yourself. Doing so may cause an explosion and/or damage to the device(s).  
When the backup battery needs to be replaced, "Low Battery" or "No Battery" will appear on the display. In this case, contact your Yamaha dealer and have qualified Yamaha service personnel replace the backup battery.

Yamaha cannot be held responsible for damage caused by improper use or modifications to the device, or data that is lost or destroyed.

PA-6 2/2

## NOTICE

**To avoid the possibility of malfunction/damage to the product, damage to data, or damage to other property, follow the notices below.**

### Handling and maintenance

- Do not use the device in the vicinity of a TV, radio, stereo equipment, mobile phone, or other electric devices. Otherwise, the device, TV, or radio may generate noise.
- Do not expose the device to excessive dust or vibration, or extreme cold or heat (such as in direct sunlight, near a heater, or in a car during the day), in order to prevent the possibility of panel disfiguration, unstable operation, or damage to the internal components.
- Do not place vinyl, plastic or rubber objects on the device, since this might discolor the panel.  
When cleaning the device, use a dry and soft cloth. Do not use paint thinners, solvents, cleaning fluids, or chemical-impregnated wiping cloths.
- Condensation can occur in the device due to rapid, drastic changes in ambient temperature—when the device is moved from one location to another, or air conditioning is turned on or off, for example. Using the device while condensation is present can cause damage. If there is reason to believe that condensation might have occurred, leave the device for several hours without turning on the power until the condensation has completely dried out.
- Do not apply oil, grease, or contact cleaner to the faders. Doing so may cause problems with electrical contact or fader motion.
- Always turn the power off when the device is not in use.

### Saving your data

- This product utilizes an internal backup battery\* that is used to retain your data after the product is turned off. The backup battery is a consumable item. We recommend you replace the backup battery before it is depleted, otherwise data retained in memory will be lost. When the backup battery needs to be replaced, "Low Battery" or "No Battery" will appear on the display. In this case, contact your Yamaha dealer and have qualified Yamaha service personnel replace the backup battery. The average life of the backup battery is approximately five years, depending on operating conditions.
  - \* The follow data are retained by the backup battery.
    - Internal clock information  
No other data relies on the backup battery, therefore no other data will be lost if the backup battery is depleted.
- This product regularly saves the state of its workspace so that it can return to the previous state when the product is turned on. To ensure that the state is saved properly, wait at least 10 seconds after performing the last operation before turning the product off.

### Connectors

- XLR-type connectors are wired as follows (IEC60268 standard):  
pin 1: ground, pin 2: hot (+), and pin 3: cold (-).

### Information

- Copying of the commercially available musical data including but not limited to MIDI data and/or audio data is strictly prohibited except for your personal use.
- The illustrations and LCD screens as shown in this manual are for instructional purposes only.
- Steinberg Media Technologies GmbH and Yamaha Corporation make no representations or warranties with regard to the use of the software and documentation and cannot be held responsible for the results of the use of this manual and the software.
- Windows is a registered trademark of Microsoft® Corporation in the United States and other countries.
- Apple, iPad and iPod are trademarks of Apple Inc., registered in the U.S. and other countries.
- IOS is a trademark or registered trademark of Cisco in the U.S. and other countries and is used under license.
- Steinberg and Nuendo are registered trademarks of Steinberg Media Technologies GmbH.
- The company names and product names in this manual are the trademarks or registered trademarks of their respective companies.

- Software may be revised and updated without prior notice.
- This product contains recyclable components. When disposing of this product, please contact the appropriate local authorities.

### European Models

Purchaser/User Information specified in EN55103-2:2009.  
Conforms to Environments: E1, E2, E3 and E4

### Information for users on collection and disposal of old equipment:

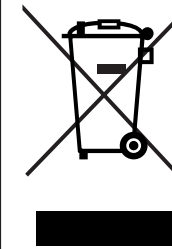

This symbol on the products, packaging, and/or accompanying documents means that used electrical and electronic products should not be mixed with general household waste. For proper treatment, recovery and recycling of old products, please take them to applicable collection points, in accordance with your national legislation.

By disposing of these products correctly, you will help to save valuable resources and prevent any potential negative effects on human health and the environment which could otherwise arise from inappropriate waste handling.

For more information about collection and recycling of old products, please contact your local municipality, your waste disposal service or the point of sale where you purchased the items.

### For business users in the European Union:

If you wish to discard electrical and electronic equipment, please contact your dealer or supplier for further information.

### Information on Disposal in other Countries outside the European Union:

This symbol is only valid in the European Union. If you wish to discard these items, please contact your local authorities or dealer and ask for the correct method of disposal.

(weee\_eu\_en\_02)

### 2-1 Intended user

This product was designed for users who are familiar with using analog mixers as part of a PA system.

### 2-2 Intended usage

This product was designed to mix multiple audio sources, such as live band instruments or audio devices used at corporate events.

### 2-3 Included items

- AC power cord
- Quick Guide (this document)
- Nuendo Live (DAW software)

### 2-4 Documentation

#### Quick Guide (this document)

This document primarily explains panel controls, functions, and basic operation of the product.

#### Reference Manual (PDF; downloadable from the website)

This document primarily explains details about functions, production operation, and effects parameters. The Reference Manual covers the TF5/TF3/TF1 consoles as well as the TF-RACK (hereafter referred to as the "TF series") and is available on the Yamaha Pro Audio website.

<http://www.yamahaproaudio.com/>

#### Using the Reference Manual

The Reference Manual is an electronic file in PDF format. You can read this document on a computer. Use Adobe® Acrobat Reader DC® to read this book on screen, search for words very quickly, print specific pages, or click links to display sections of special interest. The ability to search for words, or to follow links directly to relevant sections in the document, are helpful attributes of this electronic file format. We encourage you to take advantage of these benefits. You can download the latest Adobe Acrobat Reader DC application from the website listed below.

<http://www.adobe.com/>

### 2-5 Updating the product's software and firmware

#### Software

Your TF-series console can be used with a variety of utility software.

##### • TF Editor

This application enables you to set up and operate the console from a connected computer. You can also use the application to back up console settings or set console parameters without connecting the console.

##### • TF StageMix

This app allows you to use your iPad and a Wi-Fi connection to remote control your TF-series console.

##### • MonitorMix

This app allows you to use your mobile device and a Wi-Fi connection to adjust the TF-series console's AUX Send remotely.

##### • Yamaha Steinberg USB Driver (Windows only)

This driver software is required when connecting the console to your computer. It supports up to 34 channels of audio input and 34 channels of audio output.

Information about the software described here is available on the Yamaha Pro Audio website.

<http://www.yamahaproaudio.com/>

Information about downloading, installing and setting up the software described here is available on the website listed above. In addition, refer to the installation guide that is included with each program.

#### Firmware

The firmware contained in your TF-series console can be updated to take advantage of new features, feature improvements, and bug fixes. Details about updating the firmware are available online.

<http://www.yamahaproaudio.com/>

For information about updating and setting up the console, please refer to the firmware update guide available on the website.

### 2-6 Nomenclature used in this document

In this document, switch-type controls on the panel are called "keys."

Controls located on the panel are enclosed in [square brackets] (e.g., the [CUE] key) to distinguish them from virtual buttons and knobs displayed on screen. For certain controls, the name of the section appears before the brackets (e.g., SENDS ON FADER [AUX1] key).

The model number, serial number, power requirements, etc., may be found on or near the name plate, which is at the rear of the unit. You should note this serial number in the space provided below and retain this manual as a permanent record of your purchase to aid identification in the event of theft.

**Model No.** \_\_\_\_\_

**Serial No.** \_\_\_\_\_

(rear\_en\_01)

# 3. Panels

## 3-1 Top panel

The top panel of TF Series consoles is divided into the following sections.

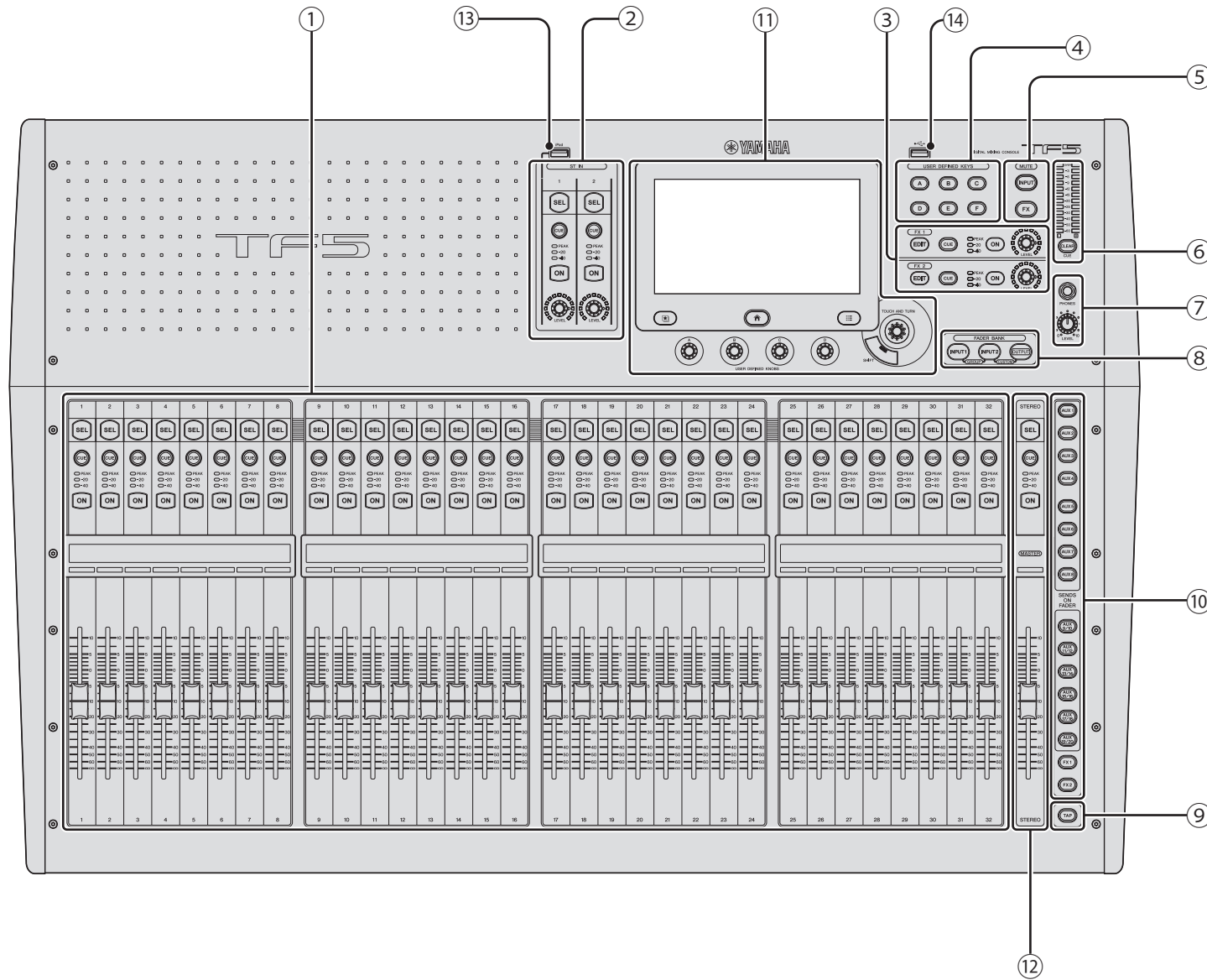

- ① Channel Strip section (page 13)
- ② ST IN (stereo input) section (page 13)
- ③ FX (effects) section (page 14)
- ④ USER DEFINED KEYS section (page 14)
- ⑤ MUTE section (page 14)
- ⑥ METER section (page 14)
- ⑦ PHONES section (page 14)
- ⑧ FADER BANK section (page 15)
- ⑨ TAP key (page 15)
- ⑩ SENDS ON FADER section (page 15)
- ⑪ Display section (page 15)
- ⑫ STEREO/MASTER section (page 17)
- ⑬ iPad connector (page 17)
- ⑭ USB connector (page 17)

## 3-2 Rear panel

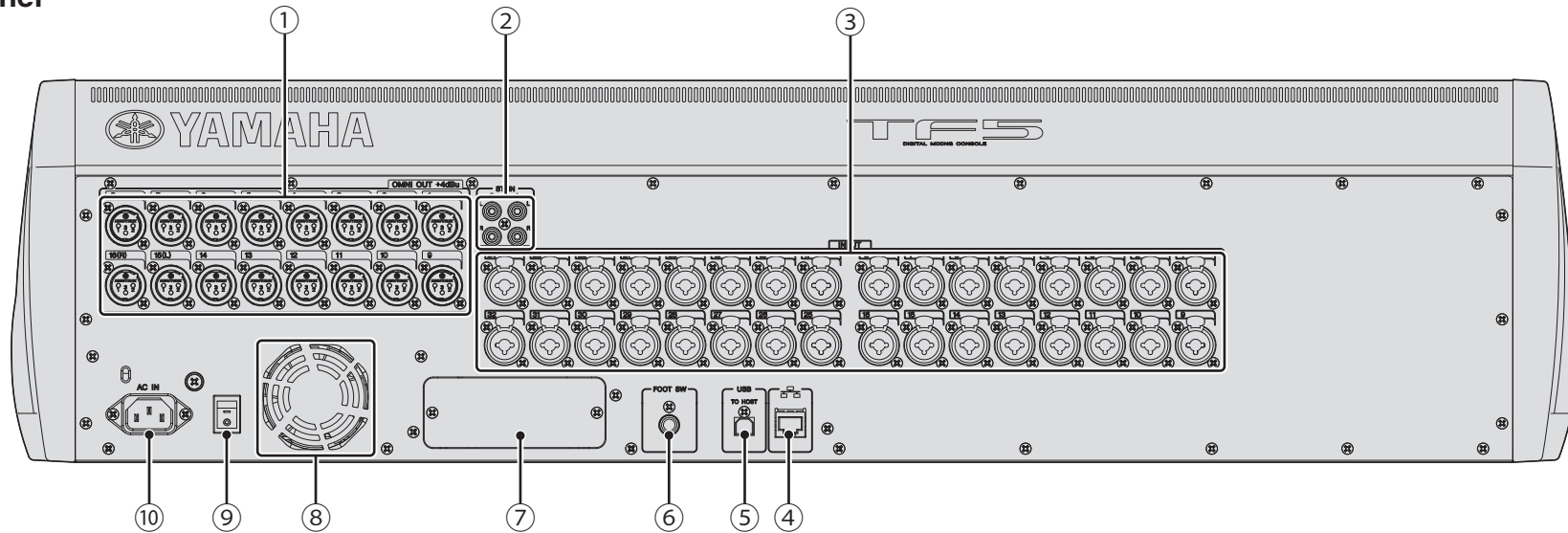
① **OMNI OUT jacks**

XLR-32 male output jacks that output analog audio signals. These jacks are used mainly to output AUX channels and STEREO channels. Nominal output level is +4 dBu. You can select which signal is output on the OMNI OUT screen.

② **ST IN jacks**

Stereo input jacks that can be used for connecting a CD player or other line level device. These jacks are unbalanced female RCA jacks. Nominal input level is -10 dBV.

③ **INPUT jacks**

Combination jacks that support both XLR and TRS phone connectors. Use these jacks to connect mics and instruments. Nominal input level is -62 dBu to +10 dBu. The head amp setting for each jack is saved in memory.

④ **NETWORK connector**

RJ-45 jack used to connect the console to a computer via an Ethernet cable (CAT5e or higher recommended). Use STP (Shielded Twisted Pair) cable to prevent electromagnetic interference.

⑤ **USB TO HOST connector**

USB connector used to connect the console to a computer, allowing the console to function as an audio interface. Supports input and output for 34 channels of 48 kHz, 24-bit audio. When using with a computer running Microsoft Windows, the Yamaha Steinberg USB Driver is required. When using a Mac, Core Audio is used and therefore no extra drivers are required.

⑥ **FOOT SW jack**

Used for connecting an optional FC5 foot switch. You can use the connected foot switch as an effect bypass switch, a mute switch, or use it to tap the delay time.



⑦ **Expansion slot**

Allows you to install an NY card, such as the NY64-D Audio Interface Card.  
(Installing an NY card → page 24)

⑧ **Exhaust holes**

The unit contains a built-in cooling fan. These holes are used to expel air from the unit. To prevent overheating or malfunction, do not block the exhaust holes.

⑨ **Power switch**

When the switch is in the  position, the power is on.  
When the switch is in the  position, the power is off.

⑩ **AC IN connector**

Connect the included power cord. When connecting to a power outlet, first connect the power cord to the console, then connect the power cord to the power outlet.

 **CAUTION**

- Make sure the unit is turned off before connecting or disconnecting the power cord.
- Disconnect the power cord from the outlet when the unit will not be used for extended periods of time.

# 4. Workflow Overview

Here's a brief overview of how to start mixing using a Presets.

## 1 Connect

Connect the instruments and mics.  
Connect output devices such as powered speakers.  
Connect the included power cord to the AC IN connector.

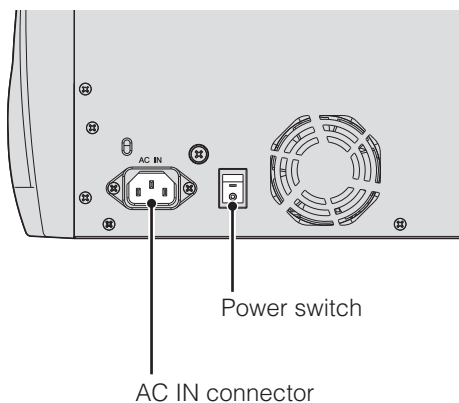

When your connections are finished, turn on the power.

### NOTICE

- This product regularly saves the state of its workspace so that it can return to the previous state when the product is turned on. To ensure that the state is saved properly, wait at least 10 seconds after performing the last operation before turning the product off.
- After turning the unit off, wait for at least 6 seconds before turning it on again. Rapidly turning the unit off and on in succession can cause it to malfunction.

## 2 Use Presets to Set Up Each Channel

### Step1

Press the [SEL] key to select a channel.

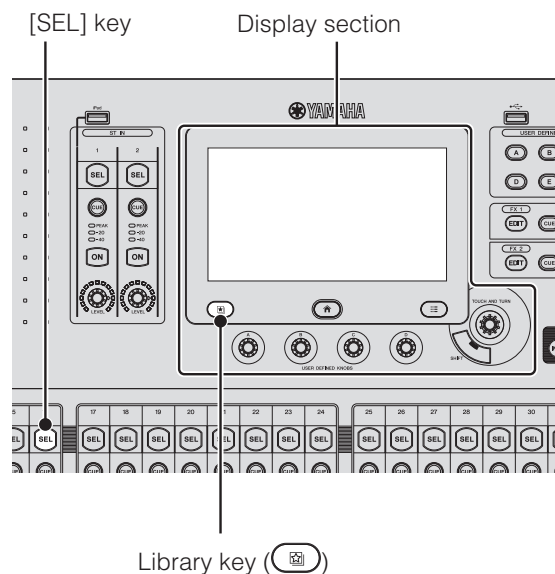

### Step2

Press the Library key (  ) to access the Library and recall a Preset.

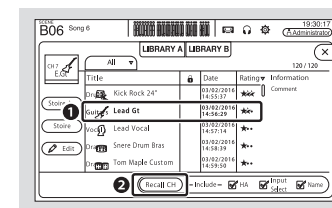

### Step3

Adjust the channel's parameters.

Adjust the input gain, EQ, compressor, and gate. These can be adjusted from the OVERVIEW screen or the individual configuration screens (page 18).

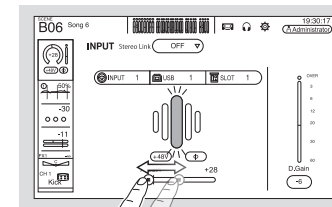

Input gain adjustment (INPUT screen)

> Repeat steps 1 to 3 and set up each channel.

### NOTE

You can set up channels without using Presets. For details about the available features and parameters, refer to the Reference Manual.

### 3 Adjust the Mix

Do a sound check and adjust the overall mix.

- Adjusting SENDS ON FADER for the level sent to AUX for each channel (page 15)
- Muting all input channels or effects (page 14)
- Turning effects on and off, adjusting the overall level of effects (page 14)

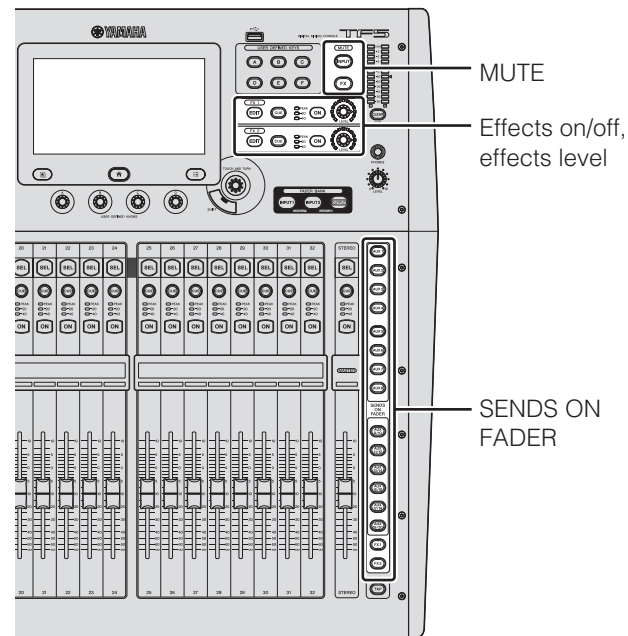

### 4 Save Your Settings

You can save your entire mix setup as a Scene. Scenes can be recalled later as needed.

(SCENE window → page 18)

You can also save individual channel setups by overwriting existing Presets or by saving them as new Presets in the Library screen.

**HINT**  
Using USER DEFINED KEYS

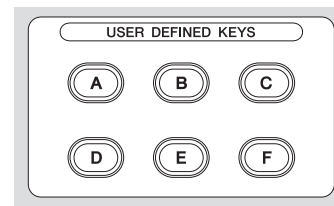

When the console is in the default state, USER DEFINED KEYS (page 14) are configured as “Direct Scene Recall” keys. You can save a Scene by pressing and holding down one of the USER DEFINED KEYS, and recall a Scene by pressing one of the USER DEFINED KEYS.

#### What is a “Preset”?

A Preset is a file stored in the Library (📁) that contains channel settings such as the type of input (instrument or mic), equalizer and compression settings, etc. The default Presets contain settings for various types of instruments, so you can use them as a starting point when setting up a channel. You can edit Presets and save them as new Presets.

#### What is a “Scene”?

A Scene is file that contains all the settings for every channel in your mix.

#### Saving a Scene

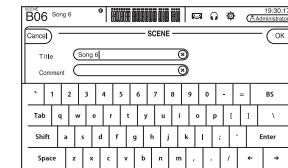

#### Recalling a Scene

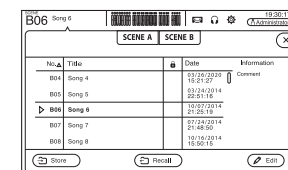

# 5. Connections

## Connecting outputs

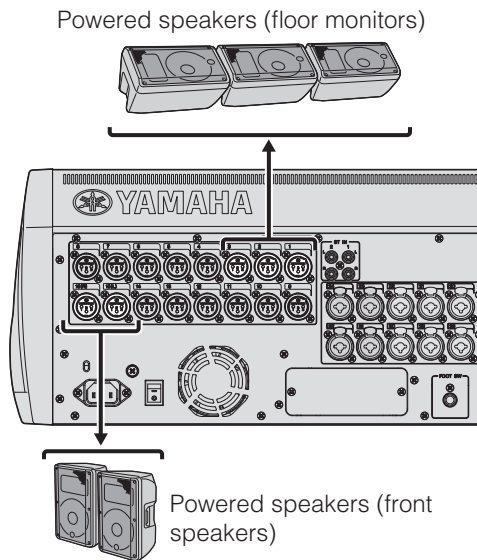

### Default signal routing for each output jack

OMNI OUT 1	AUX1 OUT
OMNI OUT 2	AUX2 OUT
:	:
OMNI OUT 12	AUX12 OUT
OMNI OUT 13	MONITOR L OUT
OMNI OUT 14	MONITOR R OUT
OMNI OUT 15 (L)	STEREO L OUT
OMNI OUT 16 (R)	STEREO R OUT

Each OMNI OUT jack is configured by default to output a bus. You can change the bus that is output on the SYSTEM OMNI OUT PATCH screen.

The OMNI OUT jacks can be configured to output the following signals. AUX1–AUX20, MATRIX1–MATRIX4, STEREO L, STEREO R, SUB, MONITOR L, MONITOR R, NO ASSIGN (no output signal assigned).

## Connecting inputs

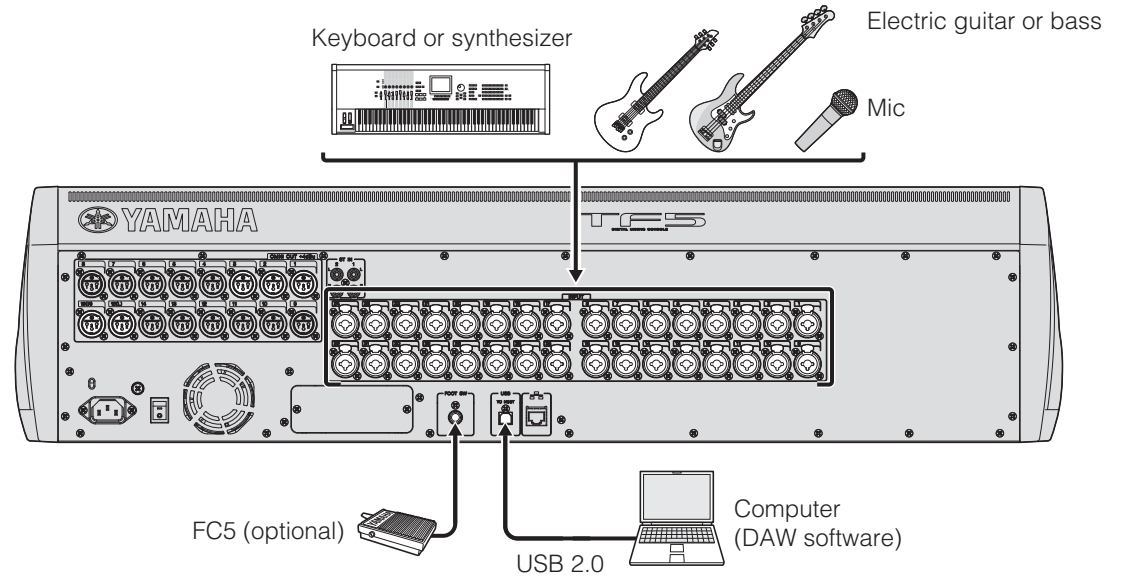

### Default signal routing for each channel

CHANNEL	TF5	TF3	TF1
CH 1	INPUT 1	INPUT 1	INPUT 1
:	:	:	:
CH 16	INPUT 16	INPUT 16	INPUT 16
CH 17	INPUT 17	INPUT 17	INPUT 1
:	:	:	:
CH 24	INPUT 24	INPUT 24	INPUT 8
CH 25	INPUT 25	INPUT 1	INPUT 9
:	:	:	:
CH 32	INPUT 32	INPUT 8	INPUT 16
CH 33	USB IN 1	USB IN 1	–
:	:	:	:
CH 40	USB IN 8	USB IN 8	–
ST IN 1L	ST IN 1L	ST IN 1L	ST IN 1L
ST IN 1R	ST IN 1R	ST IN 1R	ST IN 1R
ST IN 2L	ST IN 2L	ST IN 2L	ST IN 2L
ST IN 2R	ST IN 2R	ST IN 2R	ST IN 2R

Default signal routing for each channel is shown above. To change the signal routing, use the INPUT screen (page 20).

### HINT

#### What if I'm using condenser mics?

Phantom power must be supplied to condenser mics. Some direct boxes also need phantom power. When using phantom power, first set “+48V Master” on the SETUP screen to on, then turn phantom power on or off for each channel on the corresponding channel's INPUT screen. Make sure you turn phantom power off if it is not needed. For more details, refer to the Reference Manual.

#### Why can't I hear anything?

- Is the fader that corresponds to the desired INPUT jack raised?
- Does the input select for each channel match each INPUT jack?
- Is the channel's head amp gain set too low?
- Is the channel's [ON] key pressed?
- Is the channel muted?

This section briefly introduces the console's features.

**NOTE**

For details about the available features and parameters, refer to the Reference Manual.

## 6-1 Channel Strip section

Similarly to a channel module of a traditional analog mixer, a Channel Strip allows you to manually control the main parameters of the channel.

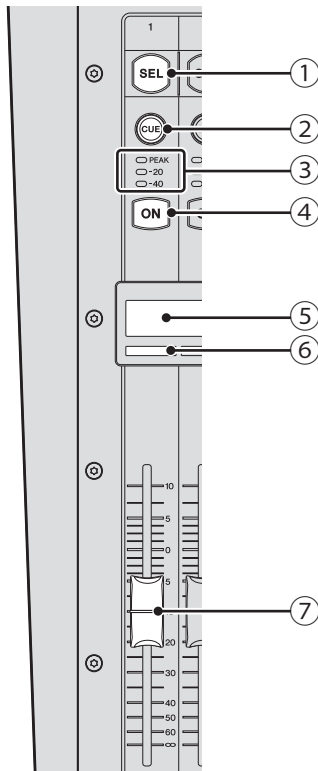

- ① **[SEL] key**  
Used to select the channel that you will control. Pressing this key will cause the key to light, which indicates that you can control the channel on the display. For stereo channels, you can press the [SEL] key to switch between the left and right channel of the stereo pair.

- ② **[CUE] key**  
Used to select the channel that will be cue-controlled. The key lights when the CUE is on.
- ③ **Meter LEDs**  
Indicate the audio signal level of the corresponding input or output channel.
- ④ **[ON] key**  
Turns the corresponding channel on and off. The key lights when the channel is on. In SENDS ON FADER mode, the key functions as an on/off switch for signals sent from the corresponding channel to the currently selected AUX or FX bus.
- ⑤ **Channel name display**  
Displays the name, ID, or port name that is assigned to the corresponding channel. It also serves as the +48V, GATE, and COMP indicator, and displays the fader value.
- ⑥ **Channel color indicator**  
Lights in the color assigned to the corresponding channel.
- ⑦ **Fader**  
Adjusts the channel's signal level. In SENDS ON FADER mode, the fader allows you to adjust the signal level sent from the corresponding channel to the currently selected AUX or FX bus.

## 6-2 ST IN (Stereo Input) section

This section controls the stereo inputs. ST IN1 is used as the playback channel for iOS devices connected to the iPad connector or audio files stored in the connected USB storage device. ST IN2 is used as the playback channel for signals received from the USB TO HOST connector (USB IN33/34). You can switch the input signals for both ST IN1 and ST IN2 from the INPUT screen.

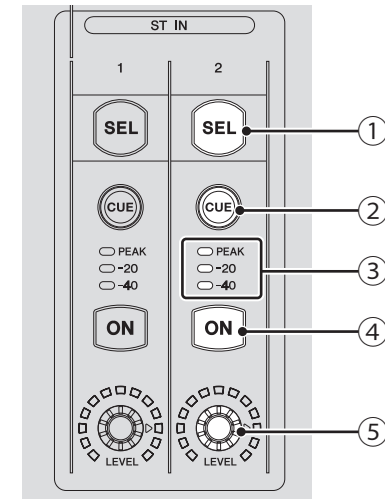

- ① **[SEL] key**  
Used to select the ST IN channel that you will control. You can press the [SEL] key to switch between the left and right channel of the stereo pair.
- ② **[CUE] key**  
Used as the cue monitor key for the ST IN channel. The key lights when the cue is on.
- ③ **Meter LEDs**  
Indicate the audio signal level of the corresponding input or output channel.
- ④ **[ON] key**  
Turns the corresponding ST IN channel on and off. The key lights when the channel is on. In SENDS ON FADER mode, turns the signal sent to the AUX or FX bus on and off.
- ⑤ **[LEVEL] knob**  
Adjusts the signal level of the corresponding ST IN channel. In SENDS ON FADER mode, adjusts the signal sent to the AUX or FX bus.

**HINT**.....  
For TF5 and TF3 consoles, ST IN can also be controlled using INPUT 2 in the FADER BANK.  
.....

## 6-3 FX section

Allows you to control the FX RTN channels.

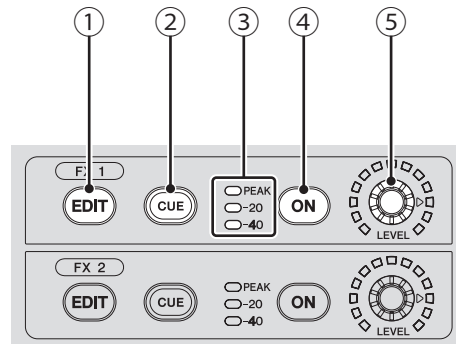

- ① **[EDIT] key**  
Displays the FX1/FX2 screen. The key lights while the FX SEND screen is displayed.
- ② **[CUE] key**  
Used as the cue monitor key for the corresponding FX channel. The key lights when the CUE is on. The key lights when the cue is on.
- ③ **Meter LEDs**  
Indicate the audio signal level of the corresponding FX channel.
- ④ **[ON] key**  
Turns the corresponding FX channel on and off.
- ⑤ **[LEVEL] knob**  
Adjusts the total output level of the corresponding FX channel.

### HINT

For TF5 and TF3 consoles, FX can also be controlled using INPUT 2 in the FADER BANK.

## 6-4 USER DEFINED KEYS section

These keys can be customized to control the desired function. Various functions are assigned by default, such as Direct Scene Recall.

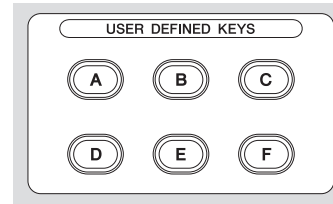

## 6-5 MUTE section

Used to mute all channels in a mute group.

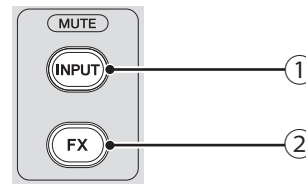

- ① **[INPUT] key**  
Allows you to mute all input channels. The key lights when the mute group is muted.
- ② **[FX] key**  
Allows you to mute the FX module. Insertion effects for channels in AUX9/10–AUX19/20 are bypassed. The key lights when the mute group is muted.

### HINT

You can remove certain input and FX channels from the mute group by turning MUTE SAFE on for the desired channels.

## 6-6 METER section

Used to monitor audio signal level and control the CUE feature.

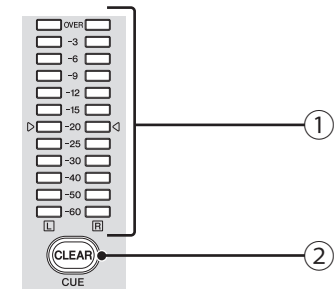

- ① **Meter LEDs**  
Indicate the audio signal level of the STEREO or CUE bus.
- ② **[CLEAR] key (CLEAR CUE key)**  
Turns off the CUE for all channels. The key lights when the CUE is turned on.

## 6-7 PHONES section

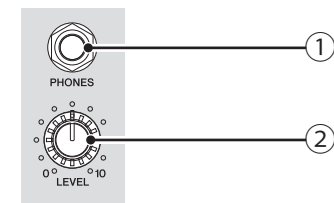

- ① **[PHONES] jack**  
This headphones jack is used to monitor signals selected for MONITOR or CUE.
- ② **[LEVEL] knob**  
Controls the level of the [PHONES] jack output.

### 6-8 FADER BANK section

Allows you to quickly assign different channels to the console's faders.

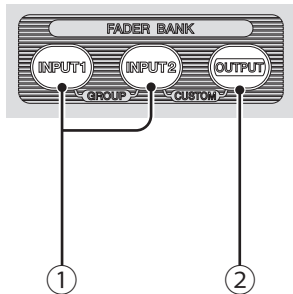

- ① **[INPUT1], [INPUT2] keys**  
Allow you to change the channels that are assigned to the console's faders. The keys light to indicate which fader bank is currently selected. You can press the [INPUT1] and [INPUT2] keys at the same time to light both keys and display the GROUP BANK in the Channel Strip section.
- ② **[OUTPUT] key**  
Displays the OUTPUT BANK in the Channel Strip section. You can press the [INPUT2] and [OUTPUT] keys at the same time to light both keys and display the CUSTOM FADER BANK in the Channel Strip section.

### 6-9 TAP section

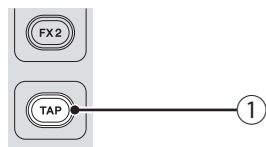

- ① **[TAP] key**  
Allows you to tap and set the delay time used for effects on FX1/FX2 and AUX9/10–AUX19/20. The key flashes in time with the tempo. The tempo you tap on the [TAP] key is applied to effects that have "Sync" set to "On". You can set the [TAP] key flashing to "Off" in the SETUP screen.

### 6-10 SENDS ON FADER section

Switches each channel strip to temporarily control the SEND LEVEL and SEND ON of the designated bus.

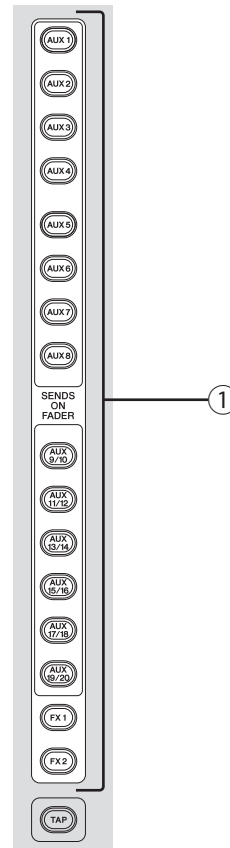

- ① **[SENDS ON FADER] keys**  
Press a key to set the corresponding bus to SENDS ON FADER mode. The key you pressed lights to indicate SENDS ON FADER mode is enabled. Press the key again to release SENDS ON FADER mode.

### 6-11 Display section

Allows to you control the console by touching the touchscreen. You can also use the knobs to perform fine adjustments. You can dive further into various features by pressing the keys to display contextual menus.

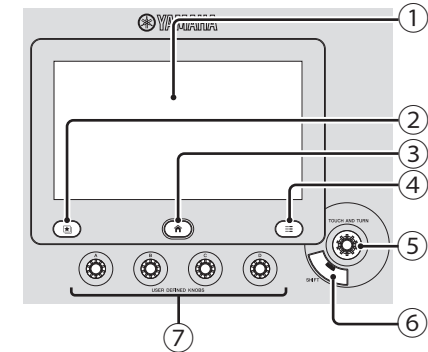

- ① **Display**  
You can use familiar touchscreen operations, such as touch, double-touch, sliding, swiping, pinching in, and pinching out.
- ② **Library key** (📖)  
Displays the Library screen, from which you can recall Presets.
- ③ **Home key** (🏠)  
Returns the display to the OVERVIEW screen. You can switch between the FADER section and the CH STRIP section by pressing the home key while the OVERVIEW screen is displayed.
- ④ **Menu key** (☰)  
Displays the menu for the current operation. The key lights when a menu is available.
- ⑤ **[TOUCH AND TURN] knob**  
Allows you to control the parameter of the feature selected on the display. For information about how to control the parameters, see "Controls and functions" (page 16).
- ⑥ **[SHIFT] key**  
Provides additional functionality, such as allowing you to switch between the F (frequency) and G (gain) parameters of the EQ handle.
- ⑦ **[USER DEFINED KNOBS]**  
These knobs allow you to adjust the parameters that you've assigned to them. You can assign parameters to each knob in the USER SETUP screen.

# Controls and functions

## Operating the display

- Changing screens

The screen switches when you touch an on-screen button.

You can touch an area of the screen to select that area, then touch it again to switch to the configuration screen for that area. If an area is displayed in pink when selected, the area contains a parameter that can be controlled with the [TOUCH AND TURN] knob.

To return to the OVERVIEW screen, press the Home key (🏠).

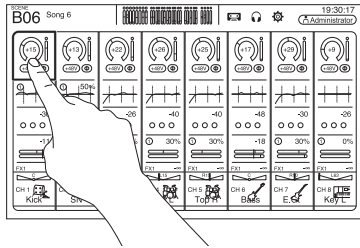

- Scrolling

In the OVERVIEW screen, you can slide the screen left and right to view different channels. When a scroll bar is displayed, you can slide the screen up and down to view more content. To scroll quickly, simply use a swiping gesture.

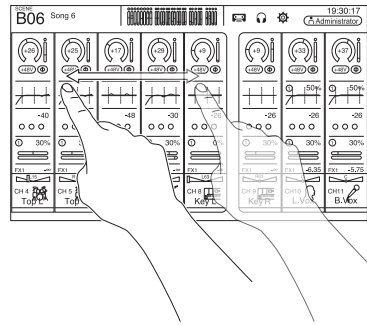

- Adjusting the Q (steepness) of the EQ

When in manual mode on the EQ screen, select one of the handles and pinch in or out to adjust the Q.

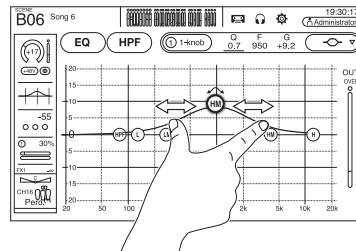

**NOTE**

In the SETUP → PREFERENCE screen, press Others → [HOME] Key and select “Both” to display the FADER section in the OVERVIEW screen. In this case, you can switch between the FADER section and the CH STRIP section by pressing the home key while the OVERVIEW screen is displayed.

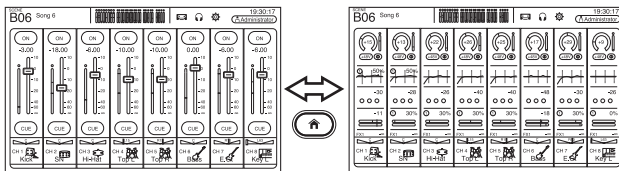

## Using the [TOUCH AND TURN] knob to control parameters

As shown below, touch the parameter you want to control (1) and then turn the [TOUCH AND TURN] knob as desired (2). A pink selection area is displayed around the selected parameter. In the OVERVIEW screen, touch an area of the screen to adjust the parameter in that area. In this case, a pink selection area is displayed around the selected area.

[TOUCH AND TURN] knob

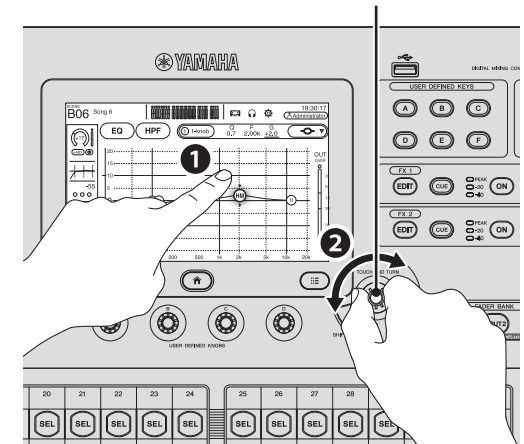

**HINT**

**What is “1-knob” mode?**

1-knob mode allows you to control multiple EQ or compressor parameters by simply turning the [TOUCH AND TURN] knob. When 1-knob mode is enabled, parameters cannot be adjusted individually. You can turn 1-knob mode on and off from the EQ and compressor screens.

**NOTE**

This functionality is not available when multiple parameters can be controlled by one knob (i.e., 1-knob mode). Use the button at the top of the screen to switch to manual mode.

## 6-12 STEREO/MASTER section

Allows you to control the main parameters of the STEREO channel.

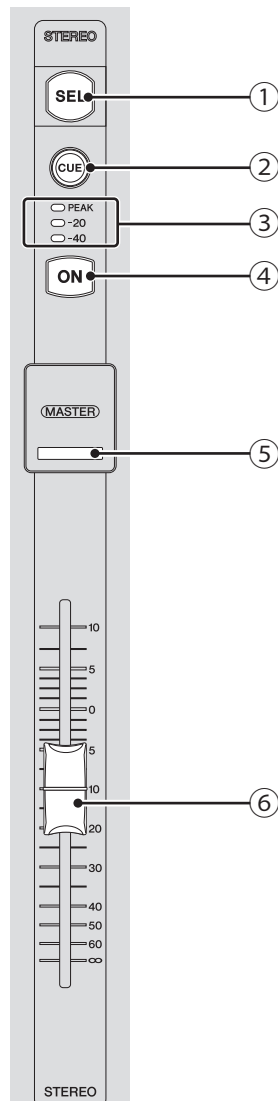

- ① **[SEL] key**  
Used to select the STEREO channel that you will control. You can press the [SEL] key to switch between controlling the left and right channel of the stereo pair.
- ② **[CUE] key**  
Used as the cue monitor key for the corresponding STEREO channel. The key lights when the CUE is on.
- ③ **Meter LEDs**  
Indicate the audio signal level of the STEREO channel. In SENDS ON FADER mode, indicate the audio signal level of the bus selected by the SENDS ON FADER key.
- ④ **[ON] key**  
Turns the STEREO channel on and off. The key lights when the channel is on. In SENDS ON FADER mode, the [ON] key turns the bus selected by the SENDS ON FADER key on and off.
- ⑤ **[MASTER] LED**  
Lights when SENDS ON FADER mode is turned on. In SENDS ON FADER mode, the entire section becomes the master section for the selected bus.
- ⑥ **Fader**  
Adjusts the output level of the STEREO channel. In SENDS ON FADER mode, the fader adjusts the signal level sent to the bus selected by the SENDS ON FADER key.

## 6-13 iPad connector

Allows you to connect an iOS device or a USB storage device.

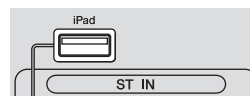

To connect an iOS device, use the dedicated cable that was included with the device. This connector allows you to use audio files on your iOS device as background music.

When a USB storage device is connected, you can use the device to play audio files or record the mixer's output directly and save it as an audio file (format: WAV).

### NOTE

When using a USB storage device for recording, use a hard disk drive or other high-speed device. (USB memory drives are not guaranteed to function properly.)

For information about compatible iOS devices, visit the Yamaha pro audio website.

<http://www.yamahaproaudio.com/>

## 6-14 USB connector

Used for connecting USB memory drives.

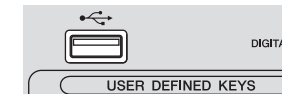

You can connect a USB memory drive and read/write data from/to the drive.

### ■ Supported formats for USB memory drives

Drives formatted using FAT32 are supported.

### ■ Preventing accidental erasure

Some USB memory drives offer a write-protect feature which prevents accidental data erasure. If you save important data on a USB memory drive, we recommend using the drive's write-protect feature to protect your data from being erased. Conversely, make sure the drive's write-protect feature is turned off before trying to save data to the drive.

### NOTE

The ACCESS indicator is displayed in the upper right of the screen while data is being accessed (read, written, erased, etc.). While this indicator is displayed, do not turn off the unit or disconnect the USB memory drive. The unit, the drive, and data stored on the drive could become damaged.

# 7. Displaying the configuration screens

You can view the following screens by touching the buttons in the OVERVIEW screen. To return to the OVERVIEW screen, press the Home key (🏠) below the display.

## METER

Displays the input and output level.

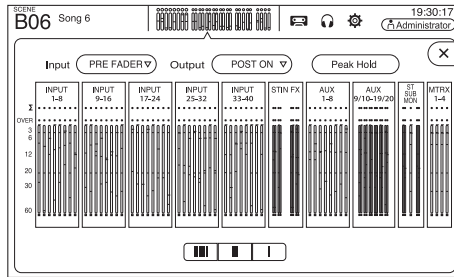

## SCENE

Used to recall previously saved mixer setups.

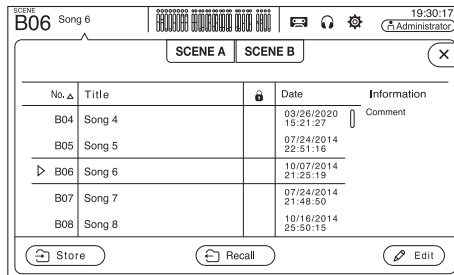

## OVERVIEW

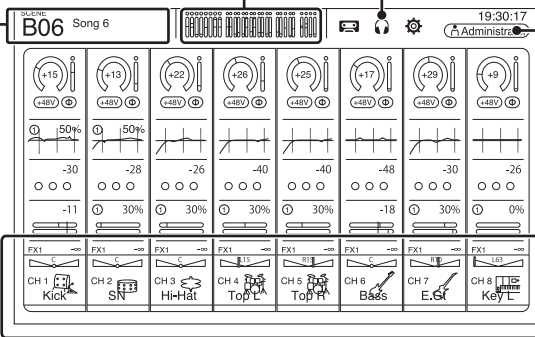

## CH VIEW

Provides an overall view of a channel's settings. You can adjust settings on this screen or switch to the dedicated screen for each setting. You can also edit the Channel Name on this screen. For information about each screen, see "Controls and functions" (page 16).

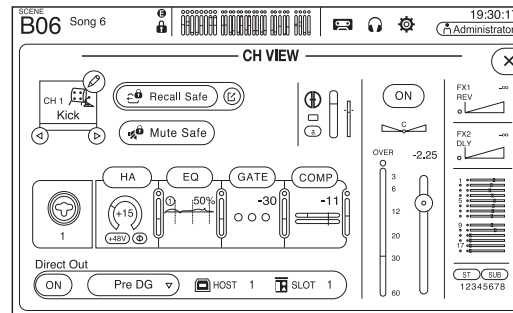

## CUE/MONITOR/OSCILLATOR

Used to manage CUE/monitor source and control oscillators.

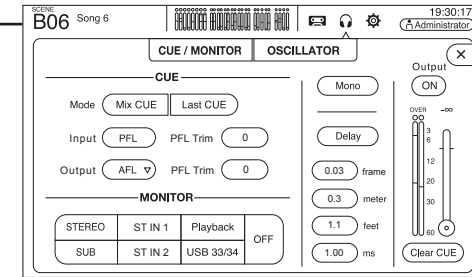

## LOGIN

Allows you to select the user, change account settings, and use the console lock feature.

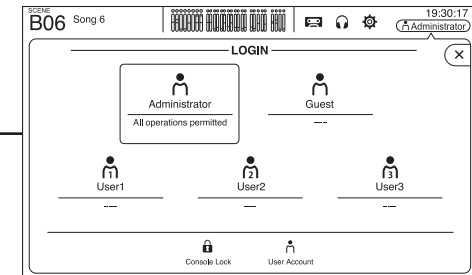

## INPUT/OUTPUT/TITLE LIST

Allows you to record directly to a computer or USB storage device, play back audio files, manage titles, etc.

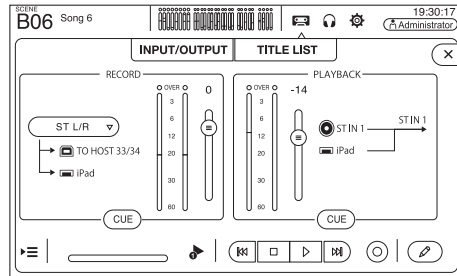

## OVERVIEW

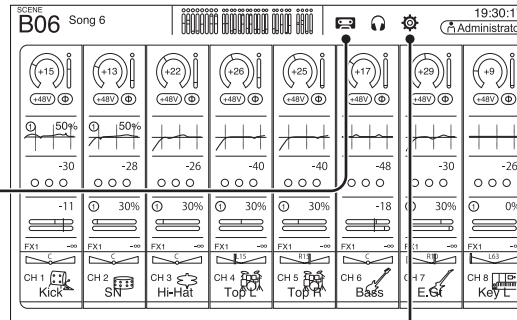

## SETUP

Used to configure general mixer settings, OMNI OUT settings, recall safe settings, assign user-defined keys and knobs, configure custom fader banks, and set up other preferences.

If a Tio1608-D is connected to the NY64-D, settings for the Tio1608-D are also available on this screen.

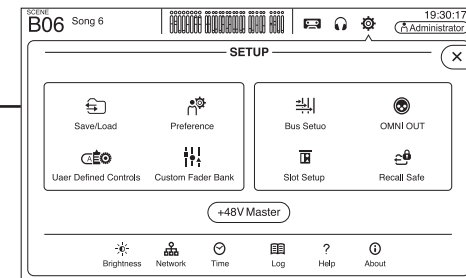

## Displaying the configuration screens

While viewing the OVERVIEW screen, you can double-touch an area of a channel to switch to that area's configuration screen.

While viewing a configuration screen, you can easily switch to another area by touching the desired area in the left side of the screen.

To return to the OVERVIEW screen, press the Home key (🏠) below the display. In the example shown here, we will explain how to switch to the different screens from the input channel screen. For details or information about other screens, refer to the Reference Manual.

### INPUT

Allows you to change input channel settings.

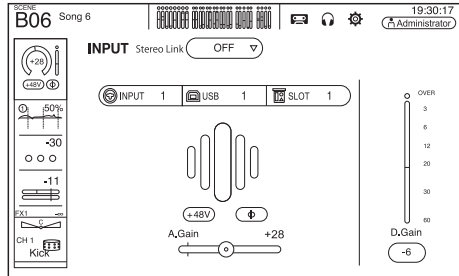

### OVERVIEW CH STRIP section

Provides an overall view of the mixer. From here you can move to the different screens.

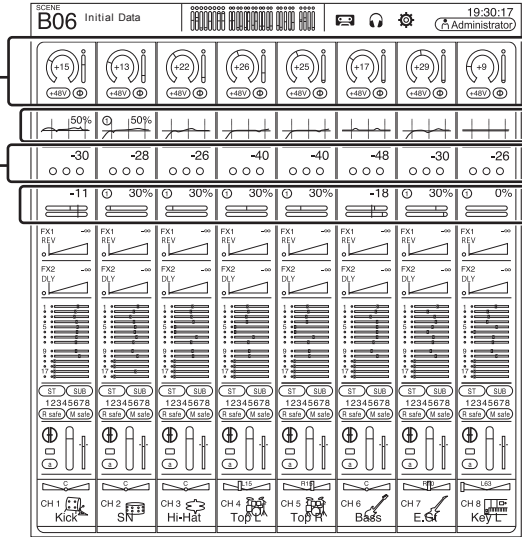

### EQ

Controls the EQ for each channel.

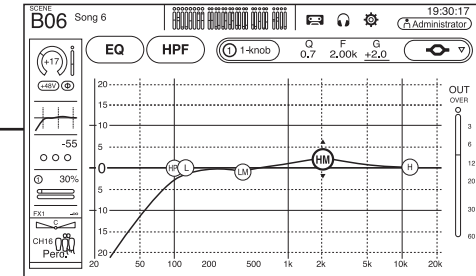

### GATE

Allows you to configure the noise gate for each channel.

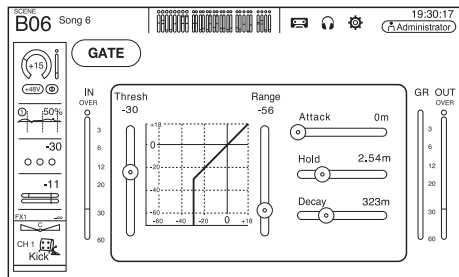

### COMP

Allows you to configure the compressor for each channel.

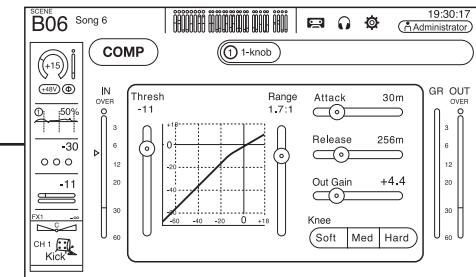

### OVERVIEW FADER section

Displays the fader level for each channel.

### NOTE

In the SETUP → PREFERENCE screen, select "Both" in the Others setting using the [HOME] key to display the FADER section in the OVERVIEW screen.

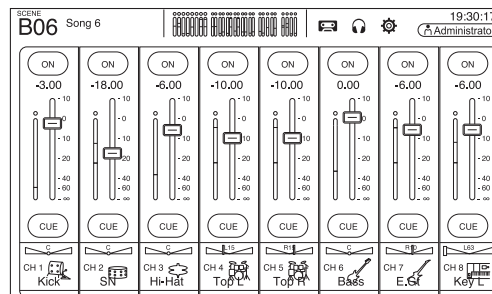

## FX1/FX2

Used to select effects and edit their parameters.

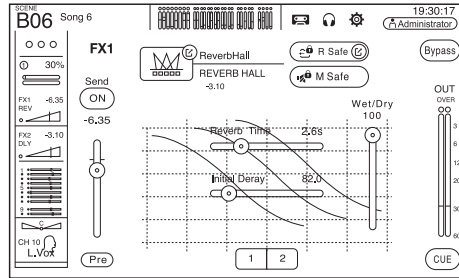

## ASSIGN

Allows you to turn Recall Safe and Mute Safe on and off, assign the channel to a DCA, and adjust the SUB bus send level.

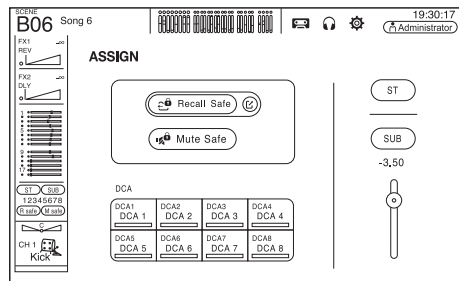

## CH VIEW

Provides an overall view of a channel's settings. You can adjust settings on this screen or switch to the dedicated screen for each setting.

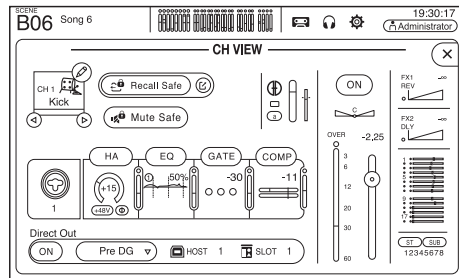

## OVERVIEW CH STRIP section

Provides an overall view of the mixer. From here you can move to the different screens.

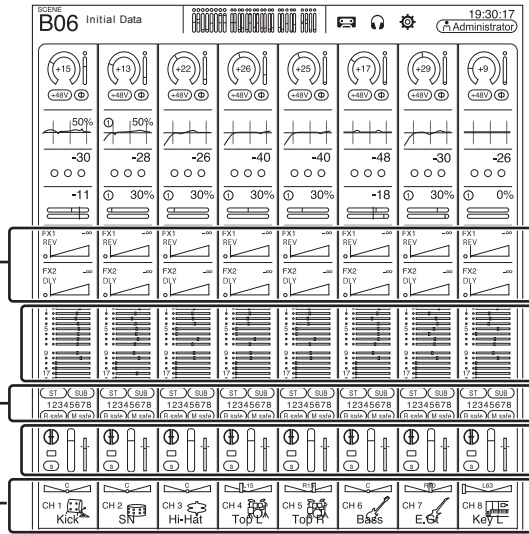

## SEND TO AUX

Allows you to set each channel's AUX bus send levels.

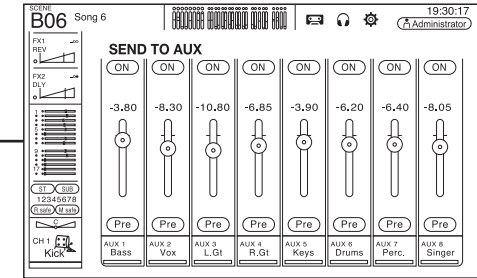

## AUTOMIXER

Sets the AUTOMIXER that can be used for CH1-CH8.

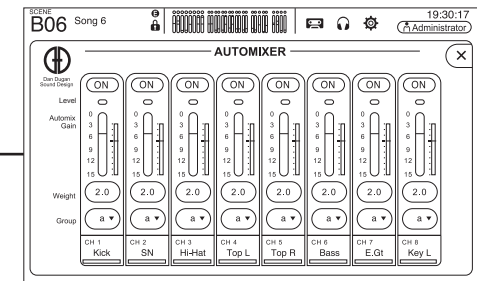

# 8. Setup

This section explains how to set up the TF series console the first time you turn it on.

## 8-1 Setting the internal clock

Set the console's internal clock, including the date, time, and format. The date and time set here is used as a timestamp when saving Scenes.

### 1 Touch the **SETUP** icon

The SETUP screen is displayed.

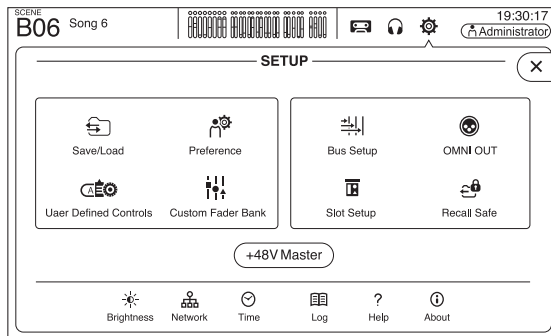

### 2 Touch the **TIME** button.

The screen for setting the time is displayed.

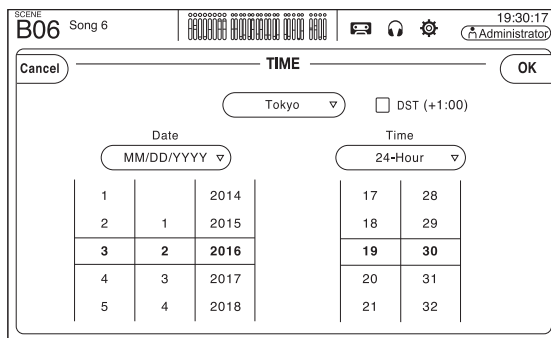

### 3 Slide the desired fields up and down to set the date and time.

### 4 When finished, touch **[OK]**.

### 5 Press the Home key .

The OVERVIEW screen is displayed.

#### **NOTE**

In addition to the internal clock, you can configure the following items. For details, refer to the Reference Manual.

- AUX bus signal type
- Network settings
- OMNI OUT settings
- Recall Safe channels
- Settings related to controlling the Tio1608-D that is connected to the NY64-D

## 8-2 Initialization (factory reset)

In the event that an internal memory error occurs or you have forgotten your password and cannot operate the console, you can use the following procedure to initialize the console.

#### **NOTE**

All information that you have stored in the unit will be erased when you initialize the unit.

Use caution when performing this procedure.

### 1 Turn on the console while holding down the Home key .

### 2 When the maintenance screen appears, press the **Initialize All Memories** button.

All settings will be restored to the factory defaults.

### 8-3 Attaching the optional Rack Mount Kit (RK5014) (TF1 only)

The procedure is the same for the left and right sides of the console. The right side is shown here.

#### Precautions when rackmounting

This unit is rated for operation at ambient temperatures ranging from 0 to 40 °C. If you install this unit in a poorly ventilated rack along with other devices, the ambient temperature inside the rack may rise, resulting in inefficient performance. Be sure to follow the guidelines below to prevent overheating.

- When mounting this unit in a rack with devices such as power amplifiers that generate a significant amount of heat, leave more than 1 U of space between this unit and other equipment. Also, either leave the open spaces uncovered or install appropriate ventilating panels to minimize the possibility of heat buildup.
- To ensure sufficient airflow, leave the rear of the rack open and position it at least 10 cm from walls or other surfaces. If the rear of the rack cannot be left open, install a commercially available fan or similar ventilation product to secure sufficient airflow. If you have installed a fan kit, there may be cases in which closing the rear of the rack will produce a greater cooling effect. Refer to the rack and/or fan unit manual for details.

#### 1 Prepare the console by removing the side pads.

- 1 Remove the two screws that secure each side pad.
- 2 Slide and remove the side pads as shown.

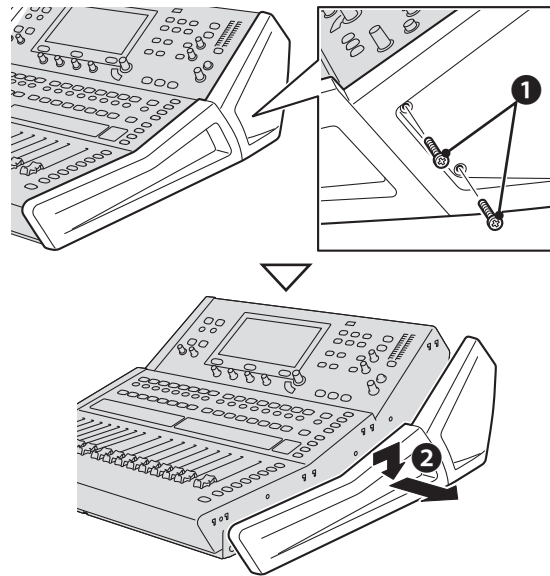

#### 2 Attach the rack mount brackets.

- 1 Attach the rack mount brackets to the console using the 8 screws (4 per side) that were included with the Rack Mount Kit.
- 2 Make sure each bracket is firmly attached.

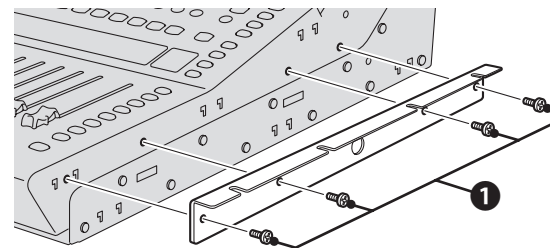

#### 3 Mount the console into the rack, and fasten it into place.

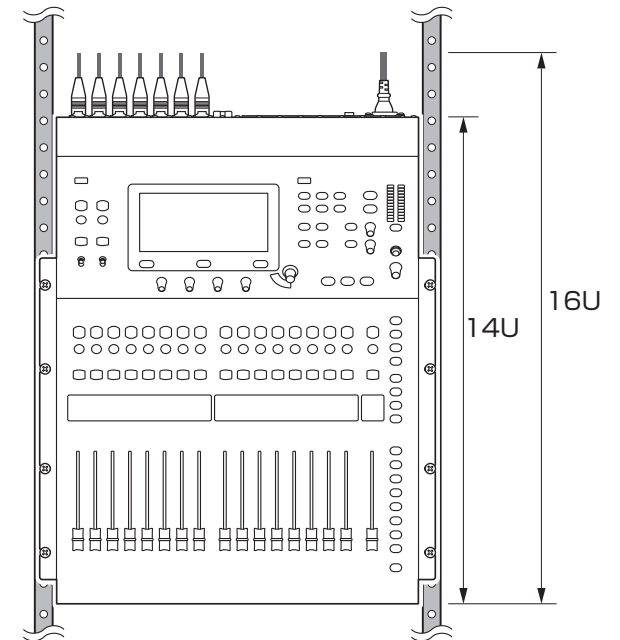

## 8-4 Installing an NY card

Before installing an NY card in the expansion slot, confirm that the card is compatible with TF-series consoles. For information about compatible cards, visit the Yamaha pro audio website. <http://www.yamahaproaudio.com/>

### 1 Confirm that the console is turned off.



**Inserting or removing a card while the unit is turned on may cause electrical shock and damage to the device.**

### 2 Remove the screws that secure the slot cover, and then remove the cover.

The screws will be used to secure the NY card. The slot cover will not be used while the card is installed; store it in a safe place for later use.

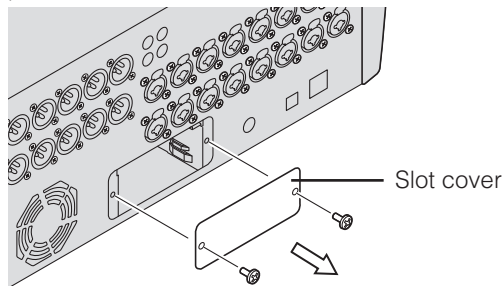

### 3 Align the sides of the NY card with the guide rails inside the expansion slot, and then insert the NY card.

Make sure you insert the card fully, so that the connection terminal on the NY card is firmly connected to the connection terminal inside the slot.

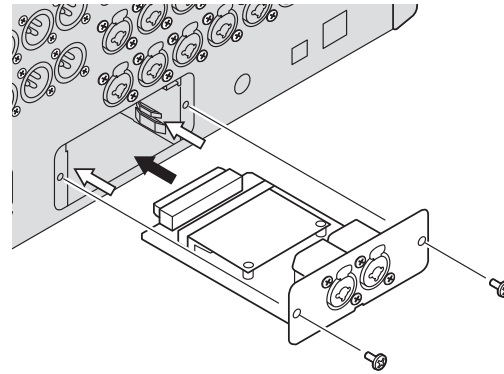

Make sure the sides of the NY card with the guide rails of the device you are installing it in.

### 4 Use the screws you removed in step 2 to secure the NY card.

Do not use the console without using the screws to secure the NY card.

Using the console without securing the card may cause damage to the product and malfunctions.

#### NOTE

When connecting a Tio1608-D, refer to the Tio1608-D Owner's Manual.

## Removing the NY card

### 1 Confirm that the console is turned off.



**Inserting or removing a card while the unit is turned on may cause electrical shock and damage to the device.**

### 2 Remove the screws that secure the NY card.

### 3 Insert a flat-head screwdriver or similar tool into the notch at the bottom of the NY card, and pull out the card slightly.

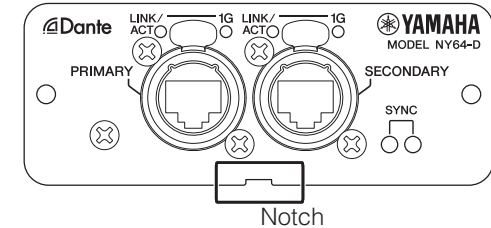

### 4 Hold the NY card by its panel, and slowly pull the card out of the console.

### 5 Attach the slot cover (removed when you installed the card) and use the screws to secure it.

Do not use the console without attaching the slot cover.

Using the console without attaching the slot cover may cause damage to the product and malfunctions.

## 9. Troubleshooting

Problems and Causes	Solutions
<b>No sound</b>	
The input source (input port) settings for the input channel are incorrect.	Check the input source (input port) settings on the INPUT screen.
The [ON] key for the corresponding channel is turned off.	Turn it on.
The fader or volume for the corresponding channel is turned down.	Raise the fader or volume.
Phantom power is not being supplied (when using a condenser mic).	Set "+48V Master" on the SETUP screen to on, and then turn on phantom power on the corresponding INPUT screen.
The mute is on.	Check the MUTE keys.
Too much gate is being applied.	Check the settings on the GATE screen.
<b>Sound level is too low</b>	
The gain is too low.	Adjust the gain on the INPUT screen.
Too much gate or compression is being applied.	Check the settings on the GATE or COMP screens.
<b>Sound is distorted</b>	
The gain is too high.	Adjust the gain on the INPUT screen.
The audio being input is too high.	Lower the volume of the audio source.
<b>No audio heard from portable audio player connected to iPad connector</b>	
The input source for ST IN 1 is not correct.	Set the INPUT source to "PLAYBACK".
The connected portable audio player is not compatible with the console.	For information about compatible portable audio players, refer to the Reference Manual. For the latest information, visit the Yamaha pro audio website.
<b>No audio heard from portable audio player connected to iPad connector</b>	
The console and computer are not assigned to the same subnet mask.	If using Static IP address provisioning, set the console to the same subnet mask as the computer. If using DHCP provisioning, connect the console and the computer to a network router, and make sure the computer is configured to receive its network settings automatically (i.e., from a DHCP server).
<b>Cannot find the driver for Mac</b>	
The console utilizes Core Audio drivers; no additional drivers are needed.	You do not need to install drivers when connecting the console to a Mac.
<b>Cannot input audio from Tio1608-D</b>	
The NY64-D is not installed correctly in the expansion slot.	Make sure the NY64-D is installed correctly.
The console is not connected correctly to the Dante network.	Make sure the console is connected correctly to the Dante network.
Settings related to the Tio1608-D are not correct.	Make sure the UNIT ID switch, QUICK CONFIG switch, and DIP switches on the rear panel of the Tio1608-D are in the correct positions.
Dante patch settings are not configured.	When using Quick Config: Make sure the QUICK CONFIG switch on the Tio1608-D is in the "on" position. Make sure the Quick Config button on the console's SLOT SETUP screen is turned on. When not using Quick Config: Use Dante Controller to configure the Dante patch settings.
Dante Device Configuration for the Tio1608-D or NY64-D is incorrect.	When using Quick Config: Enable Quick Config and then restart the console and the Tio1608-D. When not using Quick Config: Use Dante Controller to configure the devices.
<b>Cannot control Tio1608-D headamp from console (but audio input/output is functioning)</b>	
The console's HA Control is turned off.	Turn on the HA button on the console's SLOT SETUP screen.
More than two consoles or R Remote applications are connected.	Make sure there are only two consoles or R Remote applications on the Dante network that can control the Tio1608-D headamp and then restart the Tio1608-D.
Input source (input port) settings are not set to "SLOT".	Set the INPUT SELECT on the console's INPUT screen to SLOT.

# 10. Specifications

## General specifications

Sampling Frequency <sup>*1</sup>	Internal clock: 48 kHz; Dante clock: 48 kHz, 44.1 kHz (when using NY64-D)
Signal Delays	Less than 2.6 ms, INPUT to OMNI OUT, Fs=48 kHz
Fader	100 mm motorized, Resolution = 10-bit, +10 dB to -138 dB, -∞ dB all faders
Frequency Response	+0.5, -1.5 dB 20 Hz-20 kHz, refer to +4 dBu output @1kHz, INPUT to OMNI OUT
Total Harmonic Distortion <sup>*2</sup>	Less than 0.05% 20 Hz-20 kHz @+4 dBu into 600 Ω, INPUT to OMNI OUT, Input Gain=Min.
Hum & Noise <sup>*3</sup>	-128 dBu typ., Equivalent Input Noise, Input Gain=Max., -85 dBu, Residual output noise, ST master off
Dynamic Range	110 dB typ., DA Converter, 107 dB typ., INPUT to OMNI OUT, Input Gain=Min.
Crosstalk@1 kHz <sup>*4</sup>	-100 dB, adjacent INPUT/OMNI OUT channels, Input Gain=Min.
Dimensions (W x H x D)	TF5: 866 mm x 225 mm x 599 mm, 20.0 kg TF3: 716 mm x 225 mm x 599 mm, 17.0 kg TF1: 510 mm x 225 mm x 599 mm, 13.5 kg
Net Weight	
Power Requirements (wattage)	TF5: 120W, TF3: 110W, TF1: 100W
Power Requirements (voltage and hertz)	100-240 V 50/60 Hz
Temperature Range	Operating temperature range: 0-40 °C Storage temperature range: -20-60 °C
Included Accessories	Quick Guide, Power Cord

\*1. Pull-up/down function is not supported.

\*2. Total Harmonic Distortion is measured with a -18 dB/octave filter@80 kHz.

\*3. Hum & Noise are measured with an A-Weight filter.

\*4. Crosstalk is measured with a -30 dB/octave filter@22 kHz.

## Input/output characteristics

Analog input specifications							
Input jacks	GAIN	Input impedance	Source impedance	Input levels			Connectors
				Sensitivity <sup>*1</sup>	Standard level	Max. non-clipping level	
INPUT1-32 (TF5) INPUT1-24 (TF3) INPUT1-16 (TF1,TF-RACK)	+66 dB -6 dB	7.5 kΩ	50 - 600 Ω Mics or 600 Ω Lines	-82 dBu (61.6 μV) -10 dBu (245 mV)	-62 dBu (0.616 mV) +10 dBu (2.45 V)	-42 dBu (6.16 mV) +30 dBu (24.5 V)	Combo Jack (XLR-3-31 type <sup>*2</sup> or TRS phone <sup>*3</sup> ) (Balanced)
ST IN 1,2	—	10 kΩ	600 Ω Lines	-30 dBV (31.6 μV)	-10 dBV (316 mV)	+10 dBV (3.16 V)	

\*1. "Sensitivity" is the necessary input level for outputting at +4 dBu (1.23 V) or at standard levels, when all faders and level controls are set to maximum.

\*2. The XLR-3-31 connector is a balanced-type connector (1=GND, 2=HOT, 3=COLD).

\*3. The TRS phone connector is a balanced-type connector (Tip=HOT, Ring=COLD, Sleeve=GND).

\*4. This is 0 dBu=0.775 Vrms for all specifications.

\*5. The input jacks use +48V DC (phantom power), which can be set on/off for each jack in the software of this unit.

Analog output specifications						
Output jacks	Output impedance	Load impedance	Maximum output level switch	Output levels		Connectors
				Standard level	Max. non-clipping level	
OMNI OUT 1-16	75 Ω	600 Ω Lines	“+24 dBu” position (default)	+4 dBu (1.23 V)	+24 dBu (12.3 V)	XLR-3-32 type (Balanced) <sup>*1</sup>
PHONES	100 Ω	40 Ω Phones	—	3 mW <sup>*3</sup>	75 mW	Stereo Phone Jack (Unbalanced) <sup>*2</sup>

\*1. The XLR-3-32 connector is a balanced-type connector (1=GND, 2=HOT, 3=COLD).

\*2. The stereo phone jack (TRS) connector is an unbalanced-type connector (Tip=LEFT, Ring=RIGHT, Sleeve=GND).

\*3. This value is when the PHONES LEVEL knob is set 16 dB lower than the maximum position.

\*4. This is 0 dBu=0.775 Vms for all specifications.

\*5. The DA connectors all feature 24-bit linear/128x oversampling.

Digital I/O specifications				
Jacks	Format	Data length	Audio	Connectors
USB (TO HOST)	USB	24 bit	34ch Input / 34ch Output, PCM	USB (B type)
iPad	USB	—	Playback : MP3 (MPEG1 Layer3), WAV Recording : WAV	USB (A type)

Control I/O standards			
Jacks	Format	Levels	Connectors
NETWORK	IEEE802.3	10BASE-T/100BASE-TX	RJ-45
FOOT SW	—	—	TS Phone

\* The contents of this manual apply to the latest specifications as of the publishing date. To obtain the latest manual, access the Yamaha website then download the manual file.

## Source code distribution

For three years after the final factory shipment, you may request from Yamaha the source code for any portions of the product which are licensed under the GNU General Public License/GNU Lesser General Public License/RealNetworks Public Source License by writing to the following address:

10-1 Nakazawa-cho, Naka-ku, Hamamatsu, 430-8650, JAPAN

PA Division, Yamaha Corporation

The source code will be provided at no charge; however, we may require you to reimburse Yamaha for the cost of delivering the source code to you. The source code can be downloaded by visiting the following URL:

<http://www.yamahaproaudio.com/>

- Note that we shall bear no responsibility whatsoever for any damage arising from changes (additions/deletions) made to the software for this product by a third party other than Yamaha (or party authorized by Yamaha).
- Note that re-use of source code released to the public domain by Yamaha is not guaranteed. Yamaha shall not bear any responsibility whatsoever for the source code.

# Specifications

### TF5

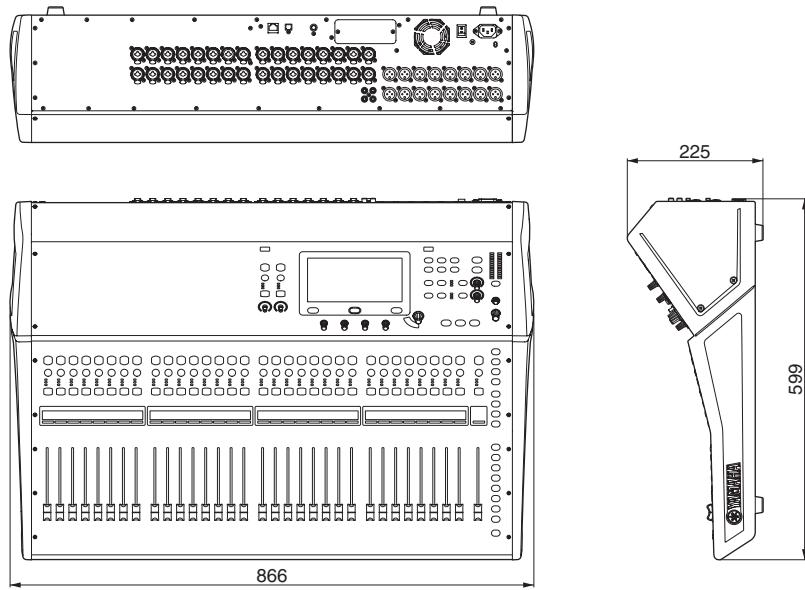

### TF3

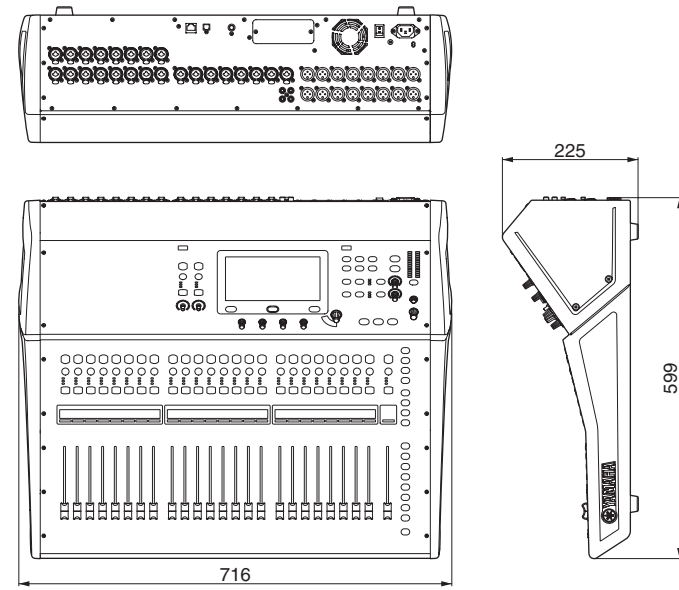

### TF1

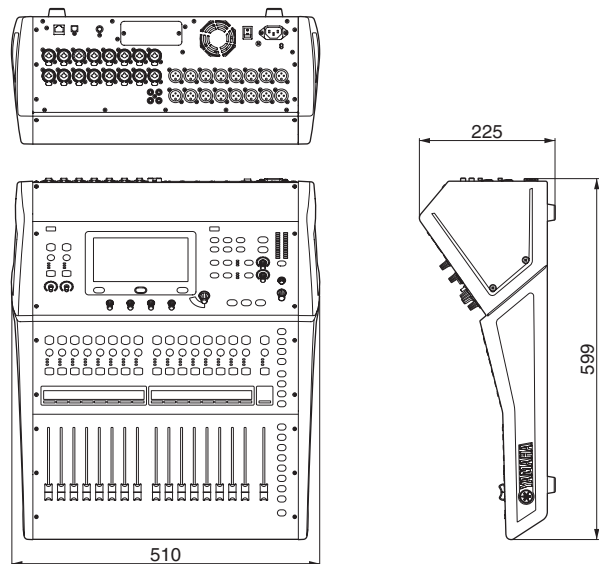

### TF1 rack mount (14U)

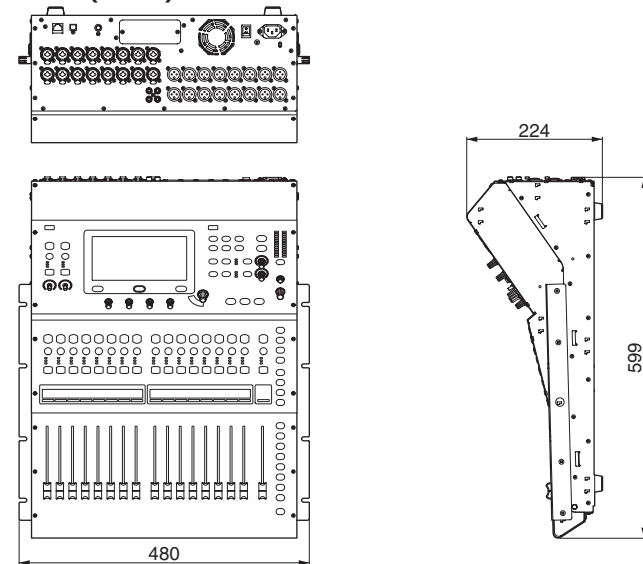

Unit: mm

# Important Notice: Guarantee Information for customers in European Economic Area (EEA) and Switzerland

<b>Important Notice: Guarantee Information for customers in EEA* and Switzerland</b>	<b>English</b>
For detailed guarantee information about this Yamaha product, and Pan-EEA* and Switzerland warranty service, please either visit the website address below (Printable file is available at our website) or contact the Yamaha representative office for your country. * EEA: European Economic Area	
<b>Wichtiger Hinweis: Garantie-Information für Kunden in der EWR* und der Schweiz</b>	<b>Deutsch</b>
Für nähere Garantie-Information über dieses Produkt von Yamaha, sowie über den Pan-EWR*- und Schweizer Garantieservice, besuchen Sie bitte entweder die folgend angegebene Internetadresse (eine druckfähige Version befindet sich auch auf unserer Webseite), oder wenden Sie sich an den für Ihr Land zuständigen Yamaha-Vertrieb. *EWR: Europäischer Wirtschaftsraum	
<b>Remarque importante: informations de garantie pour les clients de l'EEE et la Suisse</b>	<b>Français</b>
Pour des informations plus détaillées sur la garantie de ce produit Yamaha et sur le service de garantie applicable dans l'ensemble de l'EEE ainsi qu'en Suisse, consultez notre site Web à l'adresse ci-dessous (le fichier imprimable est disponible sur notre site Web) ou contactez directement Yamaha dans votre pays de résidence. * EEE : Espace Economique Européen	
<b>Belangrijke mededeling: Garantie-informatie voor klanten in de EER* en Zwitserland</b>	<b>Nederlands</b>
Voor gedetailleerde garantie-informatie over dit Yamaha-product en de garantieservice in heel de EER* en Zwitserland, gaat u naar de onderstaande website (u vindt een afdrukbaar bestand op onze website) of neemt u contact op met de vertegenwoordiging van Yamaha in uw land. * EER: Europese Economische Ruimte	
<b>Aviso importante: información sobre la garantía para los clientes del EEE* y Suiza</b>	<b>Español</b>
Para una información detallada sobre este producto Yamaha y sobre el soporte de garantía en la zona EEE* y Suiza, visite la dirección web que se incluye más abajo (la versión del archivo para imprimir esta disponible en nuestro sitio web) o póngase en contacto con el representante de Yamaha en su país. * EEE: Espacio Económico Europeo	
<b>Avviso importante: informazioni sulla garanzia per i clienti residenti nell'EEA* e in Svizzera</b>	<b>Italiano</b>
Per informazioni dettagliate sulla garanzia relativa a questo prodotto Yamaha e l'assistenza in garanzia nei paesi EEA* e in Svizzera, potete consultare il sito Web all'indirizzo riportato di seguito (è disponibile il file in formato stampabile) oppure contattare l'ufficio di rappresentanza locale della Yamaha. * EEA: Area Economica Europea	
<b>Aviso importante: informações sobre as garantias para clientes da AEE* e da Suíça</b>	<b>Português</b>
Para obter uma informação pormenorizada sobre este produto da Yamaha e sobre o serviço de garantia na AEE* e na Suíça, visite o site a seguir (o arquivo para impressão está disponível no nosso site) ou entre em contato com o escritório de representação da Yamaha no seu país. * AEE: Área Económica Europeia	
<b>Σημαντική σημείωση: Πληροφορίες εγγύησης για τους πελάτες στον ΕΟΧ* και Ελλάδα</b>	<b>Ελληνικά</b>
Για λεπτομερείς πληροφορίες εγγύησης σχετικά με το παρόν προϊόν της Yamaha και την κάλυψη εγγύησης σε όλες τις χώρες του ΕΟΧ και την Ελλάδα, επισκεφτείτε την παρακάτω ιστοσελίδα (Εκτυπώσιμη μορφή είναι διαθέσιμη στην ιστοσελίδα μας) ή απευθυνθείτε στην αντιπροσωπεία της Yamaha στη χώρα σας. * ΕΟΧ: Ευρωπαϊκός Οικονομικός Χώρος	
<b>Viktigt: Garantiinformation för kunder i EES-området* och Schweiz</b>	<b>Svenska</b>
För detaljerad information om denna Yamaha-produkt samt garantiservice i hela EES-området* och Schweiz kan du antingen besöka nedanstående webbadress (en utskriftsvänlig fil finns på webbplatsen) eller kontakta Yamahas officiella representant i ditt land. * EES: Europeiska Ekonomiska Samarbetsområdet	
<b>Viktig merknad: Garantiinformasjon for kunder i EØS* og Sveits</b>	<b>Norsk</b>
Detaljert garantiinformasjon om dette Yamaha-produktet og garantiservice for hele EØS-området* og Sveits kan fås enten ved å besøke nettstedene nedenfor (utskriftsversjon finnes på våre nettsider) eller kontakte kontakte Yamaha-kontoret i landet der du bor. *EØS: Det europeiske økonomiske samarbeidsområdet	
<b>Vigtig oplysning: Garantioplysninger til kunder i EØO* og Schweiz</b>	<b>Dansk</b>
De kan finde detaljerede garantioplysninger om dette Yamaha-produkt og den fælles garantiserviceordning for EØO* (og Schweiz) ved at besøge det websted, der er angivet nedenfor (der findes en fil, som kan udskrives, på vores websted), eller ved at kontakte Yamahas nationale repræsentationskontor i det land, hvor De bor. * EØO: Det Europæiske Økonomiske Område	

<b>Tärkeä ilmoitus: Takuutiedot Euroopan talousalueen (ETA)* ja Sveitsin asiakkaille</b>	<b>Suomi</b>
Tämän Yamaha-tuotteen sekä ETA-alueen ja Sveitsin takuuta koskevat yksityiskohtaiset tiedot saatte alla olevasta nettiosoitteesta. (Tulostettava tiedosto saatavissa sivustollamme.) Voitte myös ottaa yhteyttä paikalliseen Yamaha-edustajaan. *ETA: Euroopan talousalue	
<b>Ważne: Warunki gwarancyjne obowiązujące w EOG* i Szwajcarii</b>	<b>Polski</b>
Aby dowiedzieć się więcej na temat warunków gwarancyjnych tego produktu firmy Yamaha i serwisu gwarancyjnego w całym EOG* i Szwajcarii, należy odwiedzić wskazaną poniżej stronę internetową (Plik gotowy do wydruku znajduje się na naszej stronie internetowej) lub skontaktować się z przedstawicielstwem firmy Yamaha w swoim kraju. * EOG — Europejski Obszar Gospodarczy	
<b>Důležité oznámení: Záruční informace pro zákazníky v EHS* a ve Švýcarsku</b>	<b>Česky</b>
Podrobné záruční informace o tomto produktu Yamaha a záručním servisu v celém EHS* a ve Švýcarsku naleznete na níže uvedené webové adrese (soubor k tisku je dostupný na našich webových stránkách) nebo se můžete obrátit na zastoupení firmy Yamaha ve své zemi. * EHS: Evropský hospodářský prostor	
<b>Fontos figyelemzetés: Garancia-információk az EGT* területén és Svájcban élő vásárlók számára</b>	<b>Magyar</b>
A jelen Yamaha termékre vonatkozó részletes garancia-információk, valamint az EGT*-re és Svájcra kiterjedő garanciális szolgáltatás tekintetében keresse fel webhelyünket az alábbi címen (a webhelyen nyomtatható fájl is talál), vagy pedig lépjen kapcsolatba az országában működő Yamaha képviselői irodával. * EGT: Európai Gazdasági Térség	
<b>Oluline märkus: Garantiiteave Euroopa Majanduspiirkonna (EMP)* ja Šveitsi klientidele</b>	<b>Eesti keel</b>
Täpsema teabe saamiseks selle Yamaha toote garantii ning kogu Euroopa Majanduspiirkonna ja Šveitsi garantiiteeninduse kohta, külastage palun veebisaiti alljärgneval aadressil (meie saidil on saadaval prinditav fail) või pöörduge Teie regiooni Yamaha esinduse poole. * EMP: Euroopa Majanduspiirkond	
<b>Svarīgs paziņojums: garantijas informācija klientiem EEZ* un Šveicē</b>	<b>Latviešu</b>
Lai saņemtu detalizētu garantijas informāciju par šo Yamaha produktu, kā arī garantijas apkalpošanu EEZ* un Šveicē, lūdzu, apmeklējiet zemāk norādīto tīmekļa vietnes adresi (tīmekļa vietnē ir pieejams drukājams fails) vai sazinieties ar jūsu valsti apkalpojošo Yamaha pārstāvniecību. * EEZ: Eiropas Ekonomikas zona	
<b>Děmesio: informacija dėl garantijos pirkėjams EEE* ir Šveicarijoje</b>	<b>Lietuvių kalba</b>
Jei reikia išsamios informacijos apie šį „Yamaha“ produktą ir jo techninę priežiūrą visoje EEE* ir Šveicarijoje, apsilankykite mūsų svetainėje toliau nurodytu adresu (svetainėje yra spausdintinas failas) arba kreipkitės į „Yamaha“ atstovybę savo šaliai. *EEE – Europos ekonominė erdvė	
<b>Dôležité upozornenie: Informácie o záruke pre zákazníkov v EHP* a Švajčiarsku</b>	<b>Slovenčina</b>
Podrobné informácie o záruke týkajúce sa tohto produktu od spoločnosti Yamaha a garančnom servise v EHP* a Švajčiarsku nájdete na webovej stránke uvedenej nižšie (na našej webovej stránke je k dispozícii súbor na tlač) alebo sa obráťte na zástupcu spoločnosti Yamaha vo svojej krajine. * EHP: Európsky hospodársky priestor	
<b>Pomembno obvestilo: Informacije o garanciji za kupce v EGP* in Švici</b>	<b>Slovenščina</b>
Za podrobnejše informacije o tem Yamahinem izdelku ter garancijskem servisu v celotnem EGP in Švici, obiščite spletno mesto, ki je navedeno spodaj (natisljiva datoteka je na voljo na našem spletnem mestu), ali se obrnite na Yamahinega predstavnika v svoji državi. * EGP: Evropski gospodarski prostor	
<b>Важно съобщение: Информация за гаранцията за клиенти в ЕИП* и Швейцария</b>	<b>Български език</b>
За подробна информация за гаранцията за този продукт на Yamaha и гаранционното обслужване в паневропейската зона на ЕИП* и Швейцария или посетете посочения по-долу уеб сайт (на нашия уеб сайт има файл за печат), или се свържете с представителния офис на Yamaha във вашата страна. * ЕИП: Европейско икономическо пространство	
<b>Notificare importantă: Informații despre garanție pentru clienții din SEE* și Elveția</b>	<b>Limba română</b>
Pentru informații detaliate privind acest produs Yamaha și serviciul de garanție Pan-SEE* și Elveția, vizitați site-ul la adresa de mai jos (fișierul imprimabil este disponibil pe site-ul nostru) sau contactați biroul reprezentanței Yamaha din țara dumneavoastră. * SEE: Spațiul Economic European	

<http://europe.yamaha.com/warranty/>

## ADDRESS LIST

### NORTH AMERICA

#### CANADA

**Yamaha Canada Music Ltd.**  
135 Milner Avenue, Toronto, Ontario,  
M1S 3R1, Canada  
Tel: +1-416-298-1311

#### U.S.A.

**Yamaha Corporation of America**  
6600 Orangethorpe Avenue, Buena Park, CA  
90620, U.S.A.  
Tel: +1-714-522-9011

### CENTRAL & SOUTH AMERICA

#### MEXICO

**Yamaha de México, S.A. de C.V.**  
Av. Insurgentes Sur 1647 Piso 9, Col. San  
José Insurgentes, Delegación Benito Juárez,  
México, D.F., C.P. 03900, México  
Tel: +52-55-5804-0600

#### BRAZIL

**Yamaha Musical do Brasil Ltda.**  
Rua Fidêncio Ramos, 302 – Cj 52 e 54 – Torre  
B – Vila Olímpia – CEP 04551-010 – São  
Paulo/SP, Brazil  
Tel: +55-11-3704-1377

#### ARGENTINA

**Yamaha Music Latin America, S.A.,  
Sucursal Argentina**  
Olga Cossetini 1553, Piso 4 Norte,  
Madero Este-C1107CEK,  
Buenos Aires, Argentina  
Tel: +54-11-4119-7000

#### PANAMA AND OTHER LATIN AMERICAN COUNTRIES/ CARIBBEAN COUNTRIES

**Yamaha Music Latin America, S.A.**  
Edif. Torre Banco General, Piso 7,  
Urbanización Marbella, Calle 47 y Aquilino  
de la Guardia, Ciudad de Panamá, República  
de Panamá  
Tel: +507-269-5311

### EUROPE

#### THE UNITED KINGDOM/IRELAND

**Yamaha Music Europe GmbH (UK)**  
Sherbourne Drive, Tilbrook, Milton Keynes,  
MK7 8BL, U.K.  
Tel: +44-1908-366700

#### GERMANY

**Yamaha Music Europe GmbH**  
Siemensstrasse 22-34, 25462 Rellingen,  
Germany  
Tel: +49-4101-303-0

#### SWITZERLAND/LIECHTENSTEIN

**Yamaha Music Europe GmbH, Branch  
Switzerland in Thalwil**  
Seestrasse 18a, 8800 Thalwil, Switzerland  
Tel: +41-44-3878080

#### AUSTRIA/BULGARIA/ CZECH REPUBLIC/HUNGARY/ ROMANIA/SLOVAKIA/SLOVENIA

**Yamaha Music Europe GmbH  
Branch Austria**  
Schleiergasse 20, 1100 Wien, Austria  
Tel: +43-1-60203900

#### POLAND

**Yamaha Music Europe GmbH  
Sp.z o.o. Oddzial w Polsce**  
ul. Wielicka 52, 02-657 Warszawa, Poland  
Tel: +48-22-880-08-88

#### MALTA

**Olimpus Music Ltd.**  
Valletta Road, Mosta MST9010, Malta  
Tel: +356-2133-2093

#### NETHERLANDS/BELGIUM/ LUXEMBOURG

**Yamaha Music Europe Branch Benelux**  
Clarissenhof 5b, 4133 AB Vianen,  
The Netherlands  
Tel: +31-347-358040

#### FRANCE

**Yamaha Music Europe**  
7 rue Ambroise Croizat, Zone d'activités de  
Pariest, 77183 Croissy-Beaubourg, France  
Tel: +33-1-6461-4000

### ITALY

**Yamaha Music Europe GmbH, Branch  
Italy**  
Via Tinelli N.67/69 20855 Gerno di Lesmo  
(MB), Italy  
Tel: +39-039-9065-1

### SPAIN/PORTUGAL

**Yamaha Music Europe GmbH Ibérica,  
Sucursal en España**  
Ctra. de la Coruña km. 17,200, 28231  
Las Rozas de Madrid, Spain  
Tel: +34-91-639-88-88

### GREECE

**Philippos Nakas S.A. The Music House**  
19th klm. Leof. Lavriou 190 02 Peania –  
Attiki, Greece  
Tel: +30-210-6686168

### SWEDEN/FINLAND/ICELAND

**Yamaha Music Europe GmbH Germany  
filial Scandinavia**  
JA Wettergrensgata 1, 400 43 Göteborg,  
Sweden  
Tel: +46-31-89-34-00

### DENMARK

**Yamaha Music Denmark,  
Fillial of Yamaha Music Europe GmbH,  
Tyskland**  
Generatorvej 8C, ST. TH. , 2860 Søborg,  
Denmark  
Tel: +45-44-92-49-00

### NORWAY

**Yamaha Music Europe GmbH Germany -  
Norwegian Branch**  
Grini Næringspark 1, 1332 Østerås, Norway  
Tel: +47-6716-7800

### CYPRUS

**Yamaha Music Europe GmbH**  
Siemensstrasse 22-34, 25462 Rellingen,  
Germany  
Tel: +49-4101-303-0

### RUSSIA

**Yamaha Music (Russia) LLC.**  
Room 37, entrance 7, bld. 7, Kievskaya street,  
Moscow, 121059, Russia  
Tel: +7-495-626-5005

### OTHER EUROPEAN COUNTRIES

**Yamaha Music Europe GmbH**  
Siemensstrasse 22-34, 25462 Rellingen,  
Germany  
Tel: +49-4101-3030

### AFRICA

**Yamaha Music Gulf FZE**  
JAFZA-16, Office 512, P.O.Box 17328,  
Jebel Ali FZE, Dubai, UAE  
Tel: +971-4-801-1500

### MIDDLE EAST

#### TURKEY

**Yamaha Music Europe GmbH  
Merkezi Almanya Türkiye İstanbul Şubesi**  
Maslak Meydan Sodak, Spring Giz Plaza  
Bagimsiz Böl. No:3, Sariyer Istanbul, Turkey  
Tel: +90-212-999-8010

#### OTHER COUNTRIES

**Yamaha Music Gulf FZE**  
JAFZA-16, Office 512, P.O.Box 17328,  
Jebel Ali FZE, Dubai, UAE  
Tel: +971-4-801-1500

### ASIA

#### THE PEOPLE'S REPUBLIC OF CHINA

**Yamaha Music & Electronics (China)  
Co.,Ltd.**  
2F, Yunhedasha, 1818 Xinzha-lu, Jingan-qu,  
Shanghai, China  
Tel: +86-400-051-7700

#### INDIA

**Yamaha Music India Private Limited**  
P-401, JMD Megapolis, Sector-48,  
Sohna Road, Gurgaon-122018, Haryana, India  
Tel: +91-124-485-3300

#### INDONESIA

**PT. Yamaha Musik Indonesia (Distributor)**  
Yamaha Music Center Bldg. Jalan Jend. Gatot  
Subroto Kav. 4, Jakarta 12930, Indonesia  
Tel: +62-21-520-2577

#### KOREA

**Yamaha Music Korea Ltd.**  
8F, Dongsung Bldg. 21, Teheran-ro 87-gil,  
Gangnam-gu, Seoul, 06169, Korea  
Tel: +82-2-3467-3300

#### MALAYSIA

**Yamaha Music (Malaysia) Sdn. Bhd.**  
No.8, Jalan Perbandaran, Kelana Jaya, 47301  
Petaling Jaya, Selangor, Malaysia  
Tel: +60-3-78030900

### SINGAPORE

**Yamaha Music (Asia) Private Limited**  
Block 202 Hougang Street 21, #02-00,  
Singapore 530202, Singapore  
Tel: +65-6740-9200

### TAIWAN

**Yamaha Music & Electronics Taiwan  
Co.,Ltd.**  
2F., No.1, Yuandong Rd., Banqiao Dist.,  
New Taipei City 22063, Taiwan (R.O.C.)  
Tel: +886-2-7741-8888

### THAILAND

**Siam Music Yamaha Co., Ltd.**  
3, 4, 15, 16th Fl., Siam Motors Building,  
891/1 Rama 1 Road, Wangmai,  
Pathumwan, Bangkok 10330, Thailand  
Tel: +66-2215-2622

### VIETNAM

**Yamaha Music Vietnam Company Limited**  
15th Floor, Nam A Bank Tower, 201-203 Cach  
Mang Thang Tam St., Ward 4, Dist.3,  
Ho Chi Minh City, Vietnam  
Tel: +84-8-3818-1122

### OTHER ASIAN COUNTRIES

<http://asia.yamaha.com/>

### OCEANIA

#### AUSTRALIA

**Yamaha Music Australia Pty. Ltd.**  
Level 1, 80 Market Street, South Melbourne,  
VIC 3205, Australia  
Tel: +61-3-9693-5111

### COUNTRIES AND TRUST TERRITORIES IN PACIFIC OCEAN

<http://asia.yamaha.com/>



Yamaha Pro Audio global website  
<http://www.yamahaproaudio.com/>  
Yamaha Downloads  
<http://download.yamaha.com/>

Manual Development Group  
© 2015 Yamaha Corporation

Published 06/2017 CRMA\*. \*-01D0

ZY87130