

ANALOG/DVI²SDI/HDMI

User Manual



Rev1.0

Content

Feature	3
Front Panel.....	4
Rear Panel.....	4
Side Panel	5
DipSwitch/LED Control	6
Installation	12
Specifications.....	13
Firmware Upload	14
Appendix Table A	14

Front Panel



NO	Component	Function
1	SDI Output Port	From your SDI Display Device plug into this ports
2	HDMI output Port	From your HDMI Display Device plug into this port
3	Input Port/ Audio source LED	The LEDs are indicate Input Ports and Audio Source
5	Dipswitch	Control the Box (Input Port/Audio/Output Format)
6	Power Jack	The Power adapter plug into here

Rear Panel



NO	Component	Function
1	Phone Jack	From you Audio Device plug into this port
2	Component/CVBS/S-Video Input Port	From your YPbPr/CVBS/S-Video Device plug into this port

3	DVI-D/DVI-A Input Port	From your DVI-D/DIV-A Device plug into this port
---	------------------------	--

Side Panel



NO	Component	Function
1	USB Port	Upgrade firmware/Control Box From PC

DipSwitch/LED Control





NO	Component	Function
1	Input Source	Five of kinds input source be support (DVI-D/DV-A/YPbPr/CVBS/S-Video)
2	Audio Source	Two of kinds Audio input source (Embedded audio/L/R Audio)
3	Output format	Control Box to switch Output Format.

◆ Input Source:

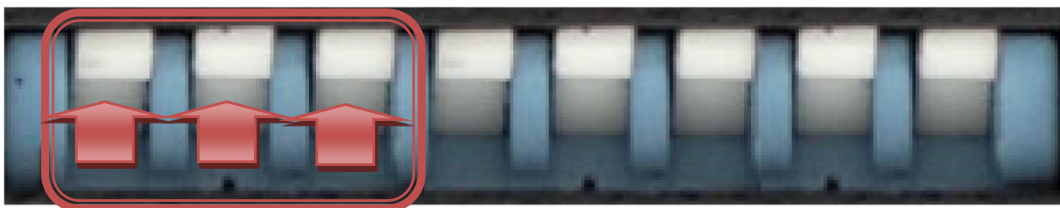
VPC-MX1 Box can choose one of three standard inputSource by DipSwitch.





Input Source	Dipswitch Indicates
DVI-D(HDMI)	↑ ↑ ↑
DVI-A(VGA)	↑ ↑ ↓
YPbPr	↑ ↓ ↑

CVBS	
S-Video(YC)	
USB Control	

◆ **Audio Source:**

VPC-MX1 Box can be select audio source from L/R Audio.









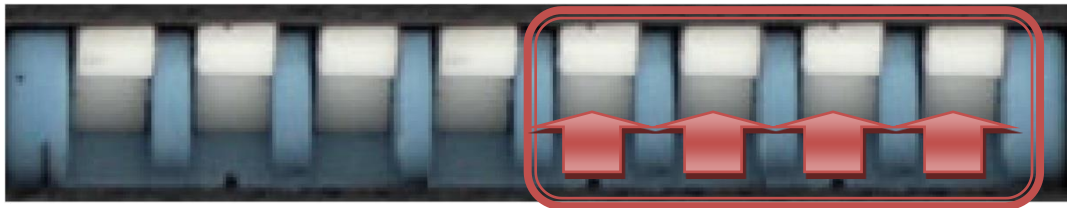

Resolution	Dipswitch Indicates
Internal (Default)	
L/R Audio	

◆ **Output Format:**

VPC-MX1box can be select 16 of kinds output format.



Resolution	Dipswitch Indicates	Resolution	Dipswitch Indicates
1920x1080p60		1920x1080i60	
1920x1080p59		1920x1080i59	
1920x1080p50		1920x1080i50	
1920x1080p30		1280x720p60	

1920x1080p29		1280x720p59	
1920x1080p25		1280x720p50	
1920x1080p24		720x480i59	
1920x1080p23		720x576i50	

◆ **LED Indicate:**

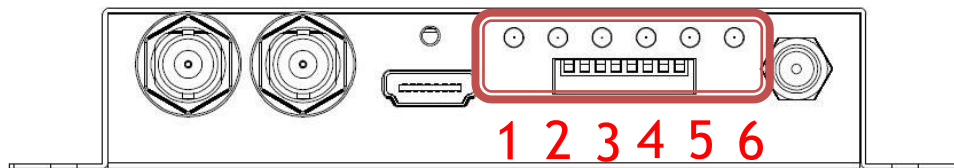

NO	Component	Function
1	Internal/L/R Audio	The LED is indicate Audio Source indicate
2	DVI-D(HDMI)	The LED is indicate DVI-D Signal indicate
3	DVI-A(VGA)	The LED is indicate DVI-A Signal indicate
4	YPbPr	The LEDs is indicate YPbPr Signal indicate
5	CVBS	The LED is indicate CVBS Signal indicate
6	S-Video	The LEDs is indicate S-Video Signal indicate

1. DVI-D + L/R Audio:

DVI-D + L/R Audio

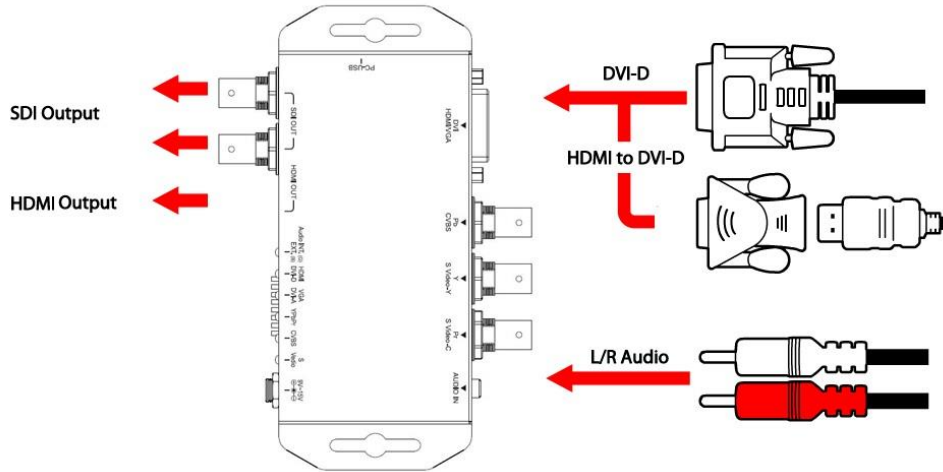

	DVI-D	DVI-A	YPbPr	Cvbs	S-Video
Locked	●	○	○	○	○
Un-locked	●	○	○	○	○
MicroVision	●(Blinking)	○	○	○	○

2. DVI-A+ L/R Audio:

DVI-A + L/R Audio

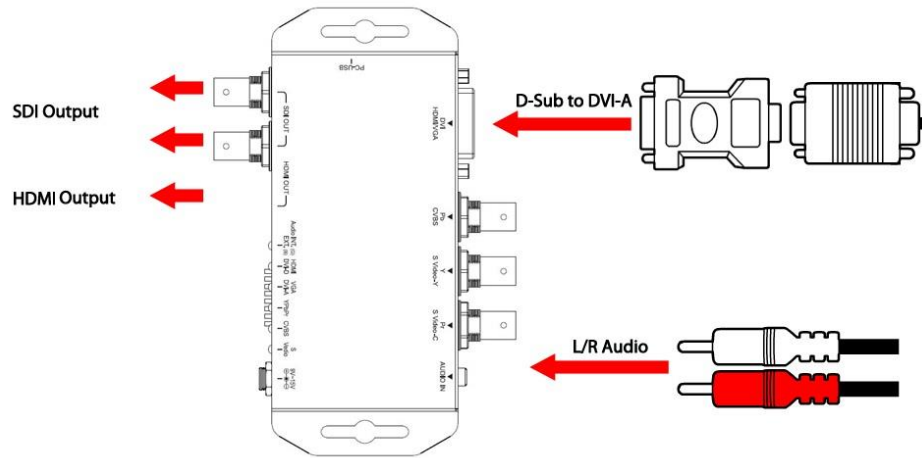

	DVI-D	DVI-A	YPbPr	Cvbs	S-Video
Locked	<input type="radio"/>	<input checked="" type="radio"/>	<input type="radio"/>	<input type="radio"/>	<input type="radio"/>
Un-locked	<input type="radio"/>	<input checked="" type="radio"/>	<input type="radio"/>	<input type="radio"/>	<input type="radio"/>

3. YPbPr + L/R Audio:

YPbPr + L/R Audio

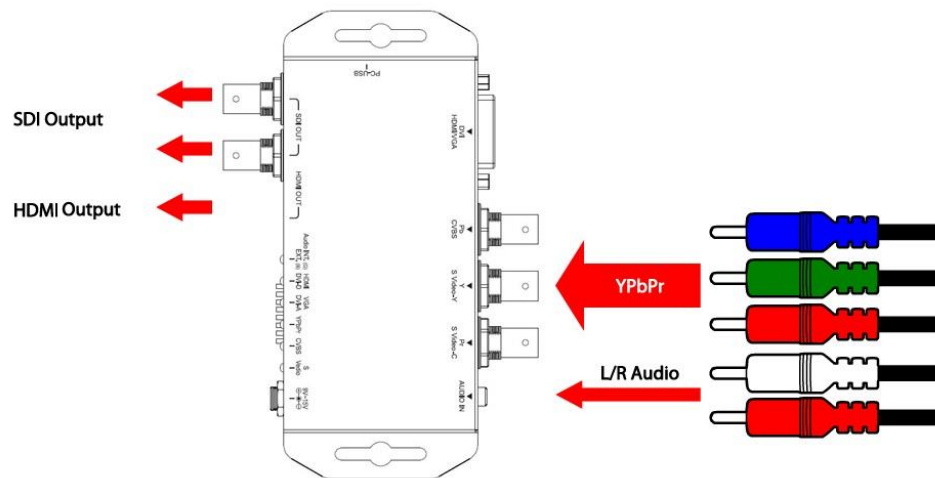

	DVI-D	DVI-A	YPbPr	Cvbs	S-Video
Locked	<input type="radio"/>	<input type="radio"/>	<input checked="" type="radio"/>	<input type="radio"/>	<input type="radio"/>
Un-locked	<input type="radio"/>	<input type="radio"/>	<input checked="" type="radio"/>	<input type="radio"/>	<input type="radio"/>

4. Composite (CVBS) + L/R Audio:

Composite(CVBS) + L/R Audio

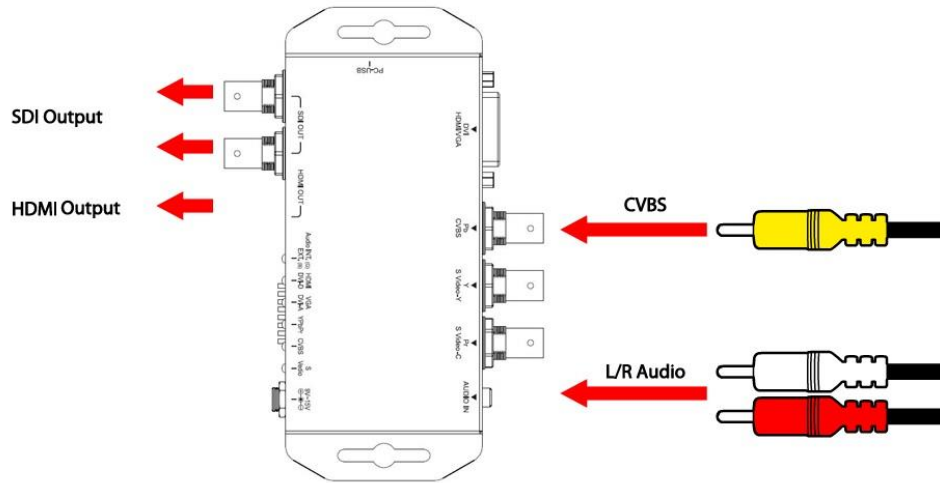

	DVI-D	DVI-A	YPbPr	Cvbs	S-Video
Locked	<input type="radio"/>	<input type="radio"/>	<input type="radio"/>	<input checked="" type="radio"/>	<input type="radio"/>
Un-locked	<input type="radio"/>	<input type="radio"/>	<input type="radio"/>	<input checked="" type="radio"/>	<input type="radio"/>
MicroVision	<input type="radio"/>	<input type="radio"/>	<input type="radio"/>	<input checked="" type="radio"/> (Blinking)	<input type="radio"/>

5. S-VIDEO + L/R Audio

Composite(CVBS) + L/R Audio

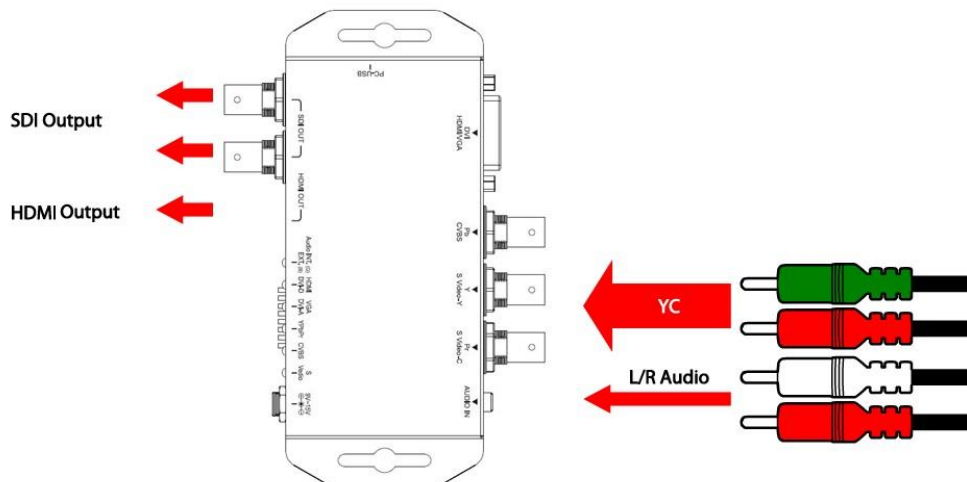

	DVI-D	DVI-A	YPbPr	Cvbs	S-Video
Locked	<input type="radio"/>	<input type="radio"/>	<input type="radio"/>	<input type="radio"/>	<input checked="" type="radio"/>
Un-locked	<input type="radio"/>	<input type="radio"/>	<input type="radio"/>	<input type="radio"/>	<input checked="" type="radio"/>

MicroVision	○	○	○	○	● (Blinking)
--------------------	---	---	---	---	--------------

6. Audio Select:

DVI-D + L/R Audio

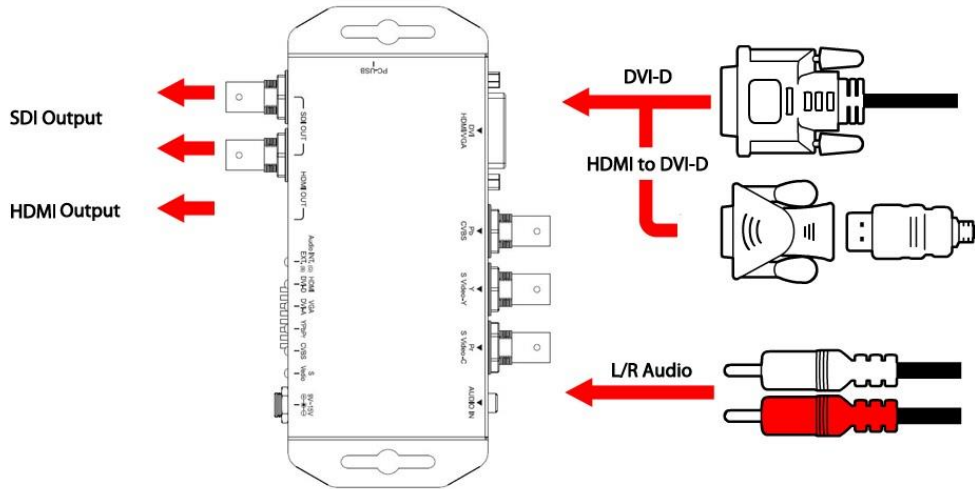

Internal Audio	●
L/R Audio	●

Installation

MULT12SDI-PRO installation consists of the following:

1. Disconnect +12DC adaptor to converter.
2. Connect Video Source to the Input Connector.
3. Connect Display Equipment to the output's connector
4. Connect the +12DC adaptor to the converter.

Specifications

DESCRIPTION	ANALOG/DVI2SDI/HDMI
SDI Format	SD-SDI, HD-SDI & 3G-SDI
SDI Transition Rate	2.970Gb/s, 10485Gb/s and 270Mb/s
Audio Support	HDMI(DVI-D) : 8-Channel L/R Audio : a. only 2 channel and splitter to 8 channel (HDMI/SDI out) b. Input impedance = 10K. c. max input level(Vrms) = 10dBV (9V p-p), or 3.16 Vrms.
Re-Sample Clock	Auto Resample audio clock to 48Khz
Coaxial Cable Type	RG6/RG59(75 Ω)
Cable Equalization	3G: 100m of RG6/ 86m of RG59 HD: 170m of RG6/ 120m of RG59 SD: 400m of RG6/ 280m of RG59 <i>*1 RG6: CANARE L-5CFB Cable / RG59: Belden 9275 Cable</i> <i>*2 Cable Length Performance: Depending on SDI Signal and Cable Quality</i>
Input Source	HDMI/VGA/YPbPr/CVBS/S-Video
Output Source	2 X SDI + 1 x HDMI (the same time)
Format Support	Appendix Table A
Firmware Updates	Via Mini-USB
Output Connector	2 x BNC [SDI] 1 x HDMI
Input Connector	1 x BNC [SDI] 1 x DVI-I [DVI-D + DVI-A] 3 x BNC [YPbPr or YC + CVBS] 1 x Phone Jack
BNC Connector	3G 75 Ω inter-locked socket
Dipswitch	Output Format/Audio Source/Input Source
Dimension	L:153mm x W:63.3mm xH:26mm
Power Source	Power Adapter: AC 100 ~ 240 V/DC (+9 ~ 15 V)

Operation Temperature	0~50°C [32~114°F]
-----------------------	-------------------

Firmware Upload

Firmware is upgradable in the field using the integrated USB port

How to Firmware upgrade:

Step 1.

Open Upload Firmware Program tools.exe and connect box to PC by USB Cable.

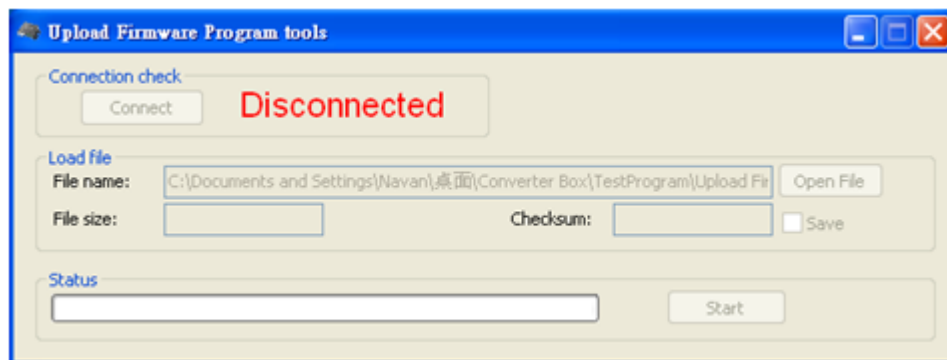

Step 2.

Plug and un-plug “DC adapter” to power on/off the converter box (the connection check status will be changed to “Connect”)

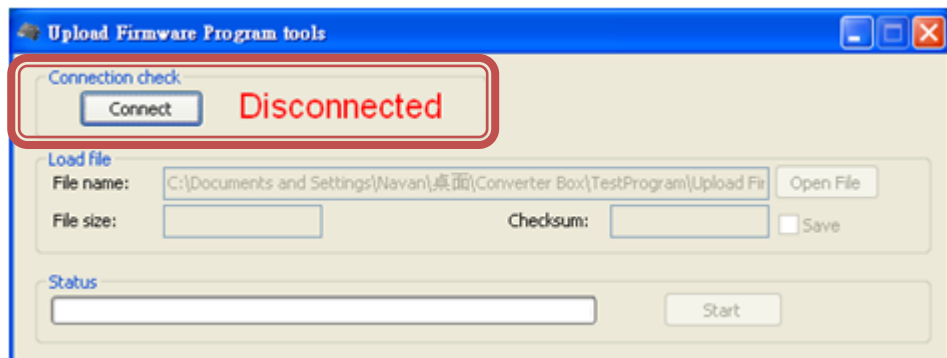

Step 3.

Plug and un-plug “DC adapter” again (the connection check status will be changed to “Connected”) and Please click the Open File button to select the firmware bin file.

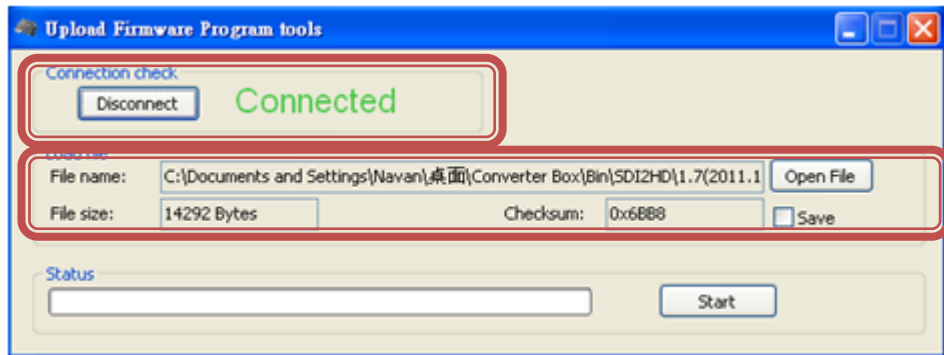

Step 4.

Please click “Start’ Button to proceed with new firmware programming. The PASS message will appear when the procedures finished.

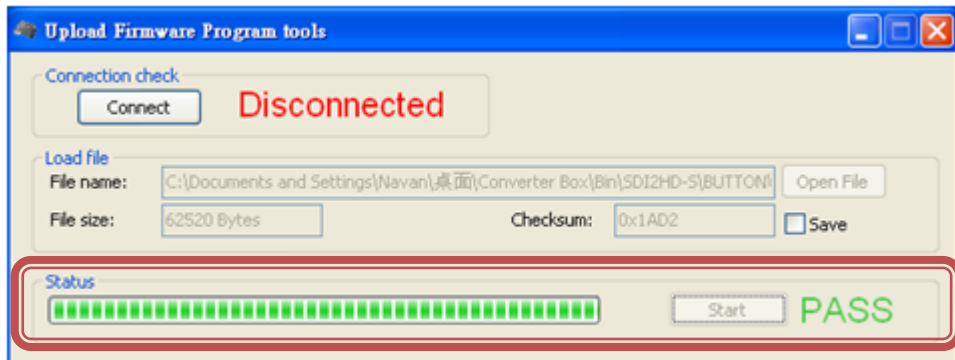

Step 5.

Close Upload Firmware Program tools

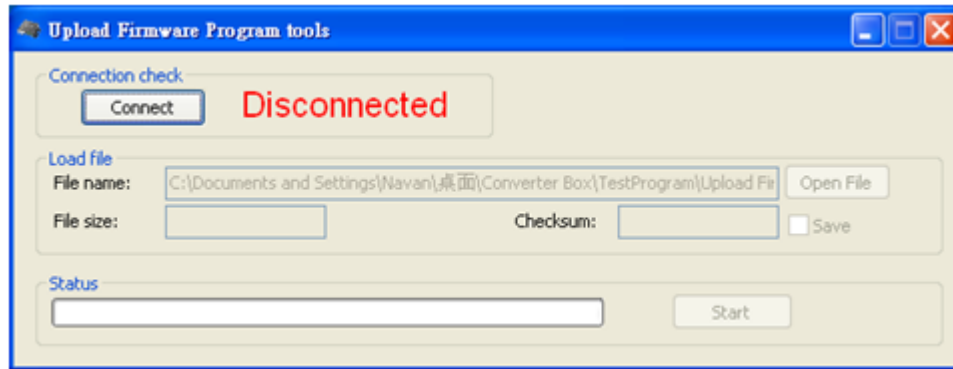

Appendix Table A

Support Input Format:

720x480i60	720x576i50	720x480 p60	720x576 p50
1280x720p60	1280x720p50	1920x1080i60	1920x1080i50
1920x1080p24	1920x1080p25	1920x1080p30	1920x1080p60
1920x1080p50			
640x350p85	640x400p85	720x400p85	640x480p60
640x480p72	640x480p75	640x480p85	800x600p56
800x600p60	800x600p72	800x600p75	800x600p85
848x480p60	1024x768p50	1024x768p59	1024x768p60
1024x768p70	1024x768p75	1024x768p85	1152x864p70
1152x864p75	1280x768pRB	1280x768p60	1280x768p75
1280x768p85	1280x800p60	1280x800p75	1280x800p85
1280x960p60	1280x960p75	1280x960p85	1280x1024p60
1280x1024p75	1280x1024p85	1360x768p60	1366x768p50
1366x768p60	1400x1050p50	1400x1050p59	1400x1050p60
1400x1050p75	1440x900p60	1440x900p75	1440x900p85
1600x1200p50	1600x1200p59	1600x1200p60	1600x1200pRB
1680x1050pRB	1680x1050p60	1920x1200pRB	2048x1052p60
2048x1080p50	2048x1080p59	2048x1080p60	

Support Output Format:

HDMI Mode		
720x480 i60	720x480 i59.94	720x576 i50

1280x720 p60	1280x720 p59.94	1280x720 p50
1920x1080 i60	1920x1080 i59.94	1920x1080 i50
1920x1080 p60	1920x1080 p59.94	1920x1080 p50
1920x1080 p30	1920x1080 p29.97	1920x1080 p25
1920 x 1080 p24	1920 x 1080 p23.98	