

MH 1 Profile

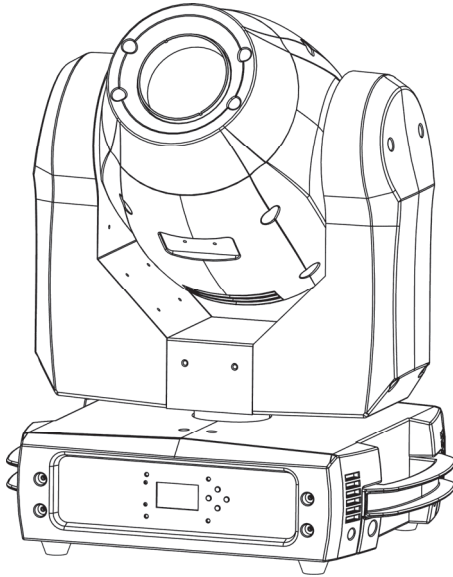

User Manual



Professional Entertainment Technology

© 2013-2014 Martin Professional. Information subject to change without notice. Martin Professional and all affiliated companies disclaim liability for any injury, damage, direct or indirect loss, consequential or economic loss or any other loss occasioned by the use of, inability to use or reliance on the information contained in this manual. The Martin logo, the RUSH by Martin logo, the RUSH by Martin name, the Martin name and all other trademarks in this document pertaining to services or products by Martin Professional or its affiliates and subsidiaries are trademarks owned or licensed by Martin Professional or its affiliates or subsidiaries.

Martin Professional • Olof Palmes Allé 18 • 8200 Aarhus N • Denmark • www.martin.com

Manual: Revision D

Table of contents

Safety information	4
Introduction	9
Before using the product for the first time	9
Physical installation	10
Fastening the fixture to a flat surface	10
Mounting the fixture on a truss	10
Securing with a safety cable	11
AC power	12
Linking fixtures to power in a chain	13
Fixture overview	13
Control data link	14
Tips for reliable data transmission	14
Connecting the DMX data link	15
Fixture setup	15
Using the control menus	15
DMX function settings	15
Show settings	16
Fixture settings	18
Display settings	19
Fixture test	20
Fixture information	20
Reset functions or effects	21
Reset factory default settings	21
Effect home position adjustment	21
Effects	22
Pan & tilt	22
Gobos	22
Iris	22
Motorized focus	23
Prism	23
Strobe effects	23
Electronic dimming	23
Color wheels	23
Maintenance	24
Cleaning	24
Changing the primary fuse	25
Gobo replacement	25
DMX protocol	27
Control menus	31
Error messages	34
Troubleshooting	35
Specifications	37

Safety information



WARNING!

Read the safety precautions in this manual before installing, powering, operating or servicing this product.

The following symbols are used to identify important safety information on the product and in this manual:



Warning!

***Safety hazard.
Risk of severe
injury or
death.***



Warning!

***Powerful light
emission. Risk
of eye injury.***



Warning!

***Refer to
manual before
installing,
powering or
servicing.***



Warning!

***Hazardous
voltage. Risk
of lethal or
severe electric
shock.***



Warning!

***Hot surfaces
and fire
hazard.***



Warning! Risk Group 3 (high risk) product according to EN 62471. Avoid looking directly into the beam and do not view the light output with optical instruments or any device that may concentrate the beam.

This product is for professional use only. It is not for household use. It product presents risks of severe injury or death due to fire hazards, electric shock and falls. It produces a powerful, concentrated beam of light that can create a fire hazard or a risk of eye injury if the safety precautions below are not followed.

Respect all locally applicable laws, codes and regulations when installing, powering, operating or servicing the fixture.



Read this manual before installing, powering or servicing the fixture, follow the safety precautions listed below and observe all warnings in this manual and printed on the fixture. Keep this manual for future use. If you have questions about how to operate the fixture safely, please contact your RUSH by Martin™ dealer or call the Martin™ 24-hour service hotline on +45 8740 0000, or in the USA on 1-888-tech-180.

For the latest user documentation and other information about this and all Martin™ products, please visit the Martin website at <http://www.martin.com>



Protection from electric shock

Do not expose the fixture to rain or moisture.

Shut down power to the fixture before carrying out any installation or maintenance work.

Disconnect the fixture from AC power before removing or installing any cover or part and when not in use.

Ensure that the fixture is electrically connected to ground (earth).

Use only a source of AC power that complies with local building and electrical codes and has both overload and ground-fault (earth-fault) protection.

Socket outlets or external power switches used to supply the fixture with power must be located near the fixture and easily accessible so that the fixture can easily be disconnected from power.

Replace defective fuses with ones of the specified type and rating only.

Isolate the fixture from power immediately if the power plug or any seal, cover, cable, or other component is damaged, defective, deformed, wet or showing signs of overheating. Do not reapply power until repairs have been completed

Before using the fixture, check that all power distribution equipment and cables are in perfect condition and rated for the electrical requirements of all connected devices.

Use only Neutrik PowerCon cable connectors to connect to power sockets.

Do not connect devices to power in a chain that will exceed the electrical ratings of any cable or connector used in the chain.

The supplied power input cable is rated 6 A and can safely supply only one fixture with mains power. Do not connect any device to the fixture's MAINS OUT connector when using this cable. If you replace this cable and also use the replacement cable to supply only one fixture with mains power, the replacement cable must also be rated 6 A minimum, have three conductors 18 AWG or 0.75 mm² minimum conductor size, have

an outer cable diameter of 6 - 15 mm (0.2 - 0.6 in.) and be temperature-rated to suit the application. In the USA and Canada the cable must be UL listed, type SJT or equivalent. In the EU the cable must be type H05VV-F or equivalent.

To connect fixtures to mains power in a chain, you must first obtain 12 AWG or 2.5 mm² power input and throughput cables that are 16 A rated and temperature-rated to suit the application. In the USA and Canada the cables must be UL-listed, type SJT or equivalent. In the EU the cables must be type H05VV-F or equivalent. Suitable cables with Neutrik PowerCon connectors are available from Martin™ (see Accessories on page 39). If you use these cables, you can connect fixtures to power in a linked chain, MAINS OUT throughput socket to MAINS IN input socket, but do not link more than:

- four (4) RUSH MH 1 fixtures in total at 100-120 V, or
- eight (8) RUSH MH 1 fixtures in total at 200-240 V.

The voltage and frequency at the MAINS OUT socket are the same as the voltage and frequency applied to the MAINS IN socket. Only connect devices to the MAINS OUT socket that accept this voltage and frequency.



Protection from burns and fire

Do not operate the fixture if the ambient temperature (T_a) exceeds 40° C (104° F).

The surface of the product casing can reach up to 85° C (185° F) during operation. Avoid contact by persons and materials. Allow the fixture to cool for at least 10 minutes before handling.

Keep flammable materials well away from the fixture. Keep all combustible materials (e.g. fabric, wood, paper) at least 100 mm (4 in.) away from the fixture head.

Ensure that there is free and unobstructed airflow around the fixture. Provide a minimum clearance of 100 mm (4 in.) around fans and air vents.

Do not illuminate surfaces within 200 mm (7.9 ins.) of the fixture.

Do not attempt to bypass thermostatic switches or fuses.

Do not stick filters, masks or other materials onto any optical component.



Protection from eye injury

Do not stare directly into the product's light output.

Do not look at the light output with magnifiers, telescopes, binoculars or similar optical instruments that may concentrate the light output.

Ensure that persons are not looking directly into the LEDs when the product lights up suddenly. This can happen when power is applied, when the product receives a DMX signal, or when certain control menu items are selected.

To minimize the risk of eye irritation or injury, disconnect the fixture from power at all times when the fixture is not in use, and provide well-lit conditions to reduce the pupil diameter of anyone working on or near the fixture.



Protection from injury

Fasten the fixture securely to a fixed surface or structure when in use. The fixture is not portable when installed.

Ensure that any supporting structure and/or hardware used can hold at least 10 times the weight of all the devices they support.

If suspending from a rigging structure, fasten the fixture to a rigging clamp. Do not use safety cables as the primary means of support.

If the fixture is installed in a location where it may cause injury or damage if it falls, install as directed in this manual a secondary attachment such as a safety cable that will hold the fixture if a primary attachment fails. The secondary attachment must be approved by an official body such as TÜV as a safety attachment for the weight that it secures, must comply with EN 60598-2-17 Section 17.6.6 and must be capable of bearing a static suspended load that is ten times the weight of the fixture and all installed accessories.

Allow enough clearance around the head to ensure that it cannot collide with an object or another fixture when it moves.

Check that all external covers and rigging hardware are securely fastened.

Block access below the work area and work from a stable platform whenever installing, servicing or moving the fixture.

Do not operate the fixture with missing or damaged covers, shields or any optical component.

Do not lift or carry the fixture by its head. Always ensure that the fixture is supported by its base.

In the event of an operating problem, stop using the fixture immediately and disconnect it from power. Do not attempt to use a fixture that is obviously damaged.

Do not modify the fixture or install other than genuine RUSH by Martin™ parts.

Refer any service operation not described in this manual to a qualified technician.

Introduction

The MH 1 Profile is a small, powerful profile fixture incorporating a 180 W long-life LED engine. It provides two gobo wheels, the first with seven rotating gobos and the second with eight fixed gobos. The fixture has two color wheels, each with eight colors (including white), smooth electronic dimming, rotating prism effects, a mechanical focus and iris, as well as strobe effects. The device is extremely rugged, lightweight and compact, and is ideal for touring applications or small fixed installations.

The fixture can be controlled using any DMX-compliant controller. It can also function without DMX control as a standalone device running one of four pre-programmed shows, with the option of sound-activated scene triggering.

The fixture is supplied with this user manual, a 1.5 m (5 ft) power cable (local power plug not included) and two mounting brackets.

Before using the product for the first time

1. Read Safety information on page 4 before installing, powering, operating or servicing the fixture.
2. Unpack and ensure that there is no transportation damage before using the fixture. Never attempt to operate a damaged fixture.
3. If the fixture is not going to be hard-wired to a mains supply, attach a local power plug (not supplied) to the end of the supplied power cable.
4. Before operating, ensure that the voltage and frequency of the power supply match the power requirements of the fixture.
5. Check the Martin Professional website at www.martin.com for the most recent user documentation and technical information about the fixture. RUSH by Martin™ user manual revisions are identified by the revision letter at the bottom of the inside cover.

Note that whenever AC power is applied to the fixture, it will reset all effects and functions to their home positions. The fixture head will move. This process usually takes around 20 seconds.

Physical installation



Read ‘Safety information’ on page 4 before installing the fixture.

The fixture is designed for indoor use only and must be used in a dry location with adequate ventilation. Ensure that none of the fixture’s ventilation slots are blocked and ensure that the product is fastened to a secure structure or surface.

Fastening the fixture to a flat surface

The fixture can be fastened to a hard, fixed, flat surface. Ensure that the surface can support at least 10 times the weight of all fixtures and equipment to be installed on it.

Fasten the fixture securely. Do not stand it on a surface or leave it where it can be moved or fall over. If you install the fixture in a location where it may cause injury or damage if it falls, loop a securely anchored safety cable through the attachment point (arrowed in illustration below) in the base of the fixture to hold it if the primary fastening method fails.

Mounting the fixture on a truss

The fixture can be clamped to a truss or similar rigging structure. To clamp the fixture to a truss:

1. Check that the rigging structure can support at least 10 times the weight of all fixtures and equipment to be installed on it.
2. Block access under the work area.
3. See illustration on right. The fixture is supplied with two omega brackets **A**. Bolt a rigging clamp **B** securely to each bracket **A**. When installing the fixture hanging vertically, open-type clamps **B** can be used. When installing in any other orientation, half-coupler clamps **C** that completely encircle the truss chord must be used.

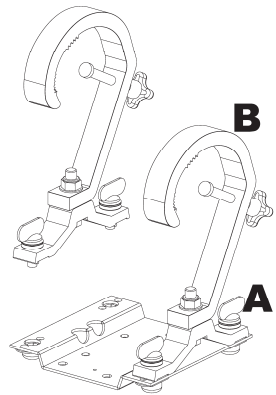

4. Fasten the brackets **A** to the base of the fixture using their quarter-turn fasteners. Turn the quarter-turn screws a full 90° to lock them.

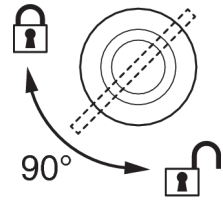

5. Working from a stable platform, hang the fixture on the truss and tighten the rigging clamps onto the truss.
6. Secure the fixture with a safety cable as directed below.
7. Check that the head will not collide with other fixtures or objects.

Securing with a safety cable

Secure the fixture with a safety cable (or other secondary attachment) that is approved for the weight of the fixture so that the safety cable will hold the fixture if a primary attachment fails. Loop the safety cable through the cutout in the fixture's baseplate (arrowed in illustration on right) and around a secure anchoring point.

RUSH by Martin™ can supply suitable safety cables and rigging clamps (see Accessories on page 39).

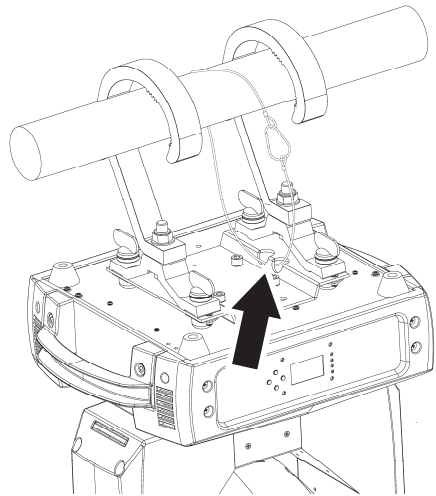

AC power



Read Safety information on page 4 before connecting the fixture to AC mains power.



Warning! The mains power input cable supplied with the fixture is rated 6 A and can supply only one fixture with mains power. Do not connect any device to the fixture's MAINS OUT power throughput socket when using this input cable. If you want to connect other fixtures to the MAINS OUT socket, see 'Linking fixtures to power in a chain' on page 13.

For protection from electric shock, the fixture must be grounded (earthed). The power distribution circuit must be equipped with a fuse or circuit breaker and ground-fault (earth-fault) protection.

Socket outlets or external power switches used to supply the fixture with power must be located near the fixture and easily accessible so that the fixtures can easily be disconnected from power.

Do not insert or remove live Neutrik PowerCon connectors to apply or cut power, as this may cause arcing at the terminals that will damage the connectors.

Do not use an external dimming system to supply power to the fixture, as this may cause damage to the fixture that is not covered by the product warranty.

The fixture can be hard-wired to a building electrical installation if you want to install it permanently, or a power plug (not supplied) that is suitable for the local power outlets can be installed on the power cable.

If you install a power plug on the power cable, follow the plug manufacturer's instructions and connect the wires in the power cable as shown in this table:

	Earth, Ground or ⊕	Neutral or N	Live or L
US system	Green	White	Black
EU system	Yellow/green	Blue	Brown

The fixture has an auto-ranging power supply that accepts AC mains power at 100-240 V at 50/60 Hz. Do not apply AC mains power at any other voltage or frequency to the fixture.

Linking fixtures to power in a chain

If you obtain a 12 AWG or 2.5mm² power input cable and 12 AWG or 2.5mm² throughput cables from Martin™ (see Accessories on page 39), you can relay mains power from one fixture to another by connecting fixtures to power in a linked daisy-chain, MAINS OUT throughput socket to MAINS IN input socket. Using 12 AWG or 2.5mm² cables from Martin™, you can link:

- Maximum four (4) RUSH MH 1 fixtures in total at 100-120 V, or
- Maximum eight (8) RUSH MH 1 fixtures in total at 200-240 V.

Fixture overview

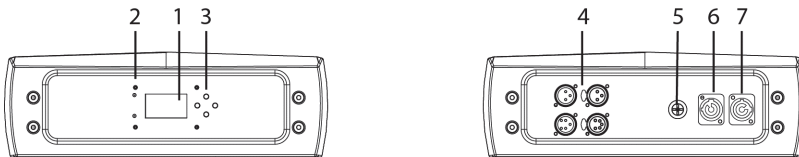

1 - Display

2 - LEDs

The fixture has two LEDs on the front of the base:

DMX	On	DMX input present
SOUND	Flashing	Sound activation

3 - Buttons

MENU	<ul style="list-style-type: none">• Activate the menu mode functions, or• Return to the previous level of the menu structure, or• Hold to exit the menus
DOWN	Go down a menu branch
UP	Go up a menu branch
ENTER	Confirm the selected function

Press and hold the MENU button to exit the menu mode.

4 - DMX XLR input/output sockets

3-pin and 5-pin XLR sockets are provided for DMX input and output (throughput).

5 - Fuse

The T 6.3 A fixture fuse is located in a fuseholder next to the power input/output connectors.

6 - Mains power input

A blue Neutrik PowerCon socket is provided to connect the fixture to AC mains power.

7 - Mains power throughput

See Safety information on page 4. The light-grey Neutrik PowerCon socket can be used to supply power to other fixtures only if the power input cable is replaced as directed in this manual and safety limits are respected.

Control data link

A DMX 512 data link is required in order to control the fixture via DMX. The fixture has 3-pin and 5-pin XLR connectors for DMX data input and output.

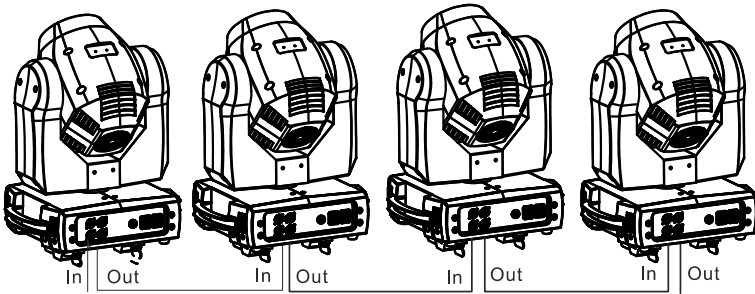

The number of daisy-chained fixtures is limited by the number of DMX channels required by the fixtures in relation to the maximum 512 channels available in one DMX universe. Note that if independent control of a fixture is required, it must have its own DMX channels. Fixtures that are required to behave identically can share the same DMX address and channels. To add more fixtures or groups of fixtures when the above limit is reached, add a DMX universe and another daisy-chained link.

Tips for reliable data transmission

Use shielded twisted-pair cable designed for RS-485 devices: standard microphone cable cannot transmit control data reliably over long runs. 24 AWG cable is suitable for runs up to 300 meters (1000 ft.). Heavier gauge cable and/or an amplifier is recommended for longer runs. The pin-out on all connectors is pin 1 = shield, pin 2 = cold (-), and pin 3 = hot (+). Pins 4 and 5 in the 5-pin XLR connectors are not used in the fixture but are available for possible additional data signals as required by the DMX512-A standard. Standard pin-out is pin 4 = data 2 cold (-) and pin 5 = data 2 hot (+).

To split the link into branches, use a splitter such as the Martin 4-Channel Opto-Isolated RS-485 Splitter/Amplifier. Terminate the link by installing a DMX termination plug in the output socket of the last fixture. The termination plug, which is a male XLR plug with a 120 Ohm, 0.25 W resistor soldered between pins 2 and 3, “soaks up” the control signal so it does not reflect and cause interference. If a splitter is used, terminate each branch of the link.

Connecting the DMX data link

To connect the fixture to data:

1. Connect the DMX data output from the controller to the first fixture’s male XLR DMX input connector.
2. Connect the first fixture’s DMX output to the DMX input of the next fixture and continue connecting fixtures output to input. Terminate the last fixture on the link with a DMX termination plug.

Fixture setup

This section explains the fixture characteristics that can be set that determine how it can be controlled and will behave. These settings are made using the menus available from the control panel, and are retained, even when the fixture is powered off.

Only the most commonly used menu options for fixture setup are described in this section. A complete map of the control menu structure and brief explanations of their purposes can be found in Control menus on page 31.

Using the control menus

To access the control menus, press the MENU button. Navigate the menu structure using the ENTER, DOWN and UP buttons. Select any required menu option using the ENTER button. To return to a higher level in the menu structure without making a change, press the MENU button.

To exit the menus, press and hold the MENU button.

DMX function settings

DMX function settings include the DMX address and a DMX value viewer.

DMX addressing

The DMX address, also known as the start channel, is the first channel used to receive instructions from a DMX controller. The fixture can be controlled using signals sent by a DMX controller over 17 channels. Each DMX controlled

fixture must have a DMX address set. For example, if a fixture has a DMX address of 10, then it uses channels 10, 11, 12, 13, 14, 15, 16, 17, 18, 19, 20, 21, 22, 23, 24, 25 and 26. The following fixture in the DMX chain could then be set to a DMX address of 27.

For independent control, each fixture must be assigned its own control channels. Two fixtures of the same type may share the same address, if identical behavior is desired. Address sharing can be useful for diagnostic purposes and symmetric control, particularly when combined with the inverse pan and tilt options.

The DMX address is configured using the DMX FUNCTIONS menu in the control panel.

To set the fixture's DMX address:

1. Select DMX FUNCTIONS and press the ENTER button.
2. Use the UP and DOWN buttons to select DMX ADDRESS and press the ENTER button to confirm. The present address will blink on the display.
3. Use the UP and DOWN buttons to select a new address.
4. Once the address has been selected, press the ENTER button to set it. Or to return to the higher level of the menu structure without making a change, press the MENU button again.

Show settings

Show settings determine the behavior of the fixture when it is disconnected from DMX and if, and how, it will run one of the onboard shows.

Offline mode

Offline mode defines what the fixture will do if it loses or is not connected to a DMX signal. There are three options M/S (enter stand-alone Show Mode), HOLD (do nothing), or BLACKOUT.

To set a fixture's offline mode:

1. Select SHOW SETTINGS and press the ENTER button to confirm.
2. Use the DOWN and UP buttons to select OFFLINE MODE and press the ENTER button to confirm.
3. Use the DOWN and UP buttons to select M/S, HOLD, or BLACKOUT.
4. Once the offline mode has been selected, press the ENTER button to set (or, to return to the higher level of the menu structure without any change press the MENU button).

Show settings

Show mode provides four preprogrammed shows. These are not accessible via DMX. Show mode can be combined with music trig sound activation to provide a synchronized light show.

To set a fixture's show mode:

1. Select SHOW SETTINGS and press the ENTER button to confirm.
2. Use the DOWN and UP buttons to select SHOW MODE and press the ENTER button to confirm.
3. Use the DOWN and UP buttons to select SHOW 1, SHOW 2, SHOW 3 or SHOW 4.
4. Once the show has been selected, press the ENTER button to set (or, to return to the higher level of the menu structure without any change press the MENU button).

Setting the focus index for gobo wheels 1 and 2

For the shows, the focus index can be set for each of the two gobo wheels, 1 (rotating gobos) and 2 (fixed gobos).

To set the focus for a gobo wheel:

1. Select SHOW SETTINGS and press the ENTER button to confirm.
2. Use the DOWN and UP buttons to select FOCUS 1 or FOCUS 2 (corresponding to wheel 1 (rotating) or wheel 2 (fixed)) and press the ENTER button to confirm.
3. Use the DOWN and UP buttons to change the focus point from 0...255.
4. Once the level has been selected, press the ENTER button to set it (or, to return to the higher level of the menu structure without any change press the MENU button).

Music trig sound activation

The fixture has a built-in microphone that can be used to synchronize its behavior to the beat of music. When the fixture is not connected to a DMX controller, and is running one of the preprogrammed shows, it can be set to trigger scene changes (effects, color changes and movement) in synch with music.

To turn on sound activation:

1. Select SHOW SETTINGS and press the ENTER button to confirm.
2. Use the DOWN and UP buttons to select SOUND TRIGGER and press the ENTER button to confirm.

3. Use the DOWN and UP buttons to select ON (sound activation on) or OFF (sound activation off).
4. Press the ENTER button to set it (or, to return to the higher level of the menu structure without any change press the MENU button).

To adjust the sensitivity of the sound-activation microphone:

1. Select SHOW SETTINGS and press the ENTER button to confirm.
2. Select SOUND SENSIVITY and press the ENTER button to confirm.
3. Use the DOWN and UP buttons to change the microphone sensitivity from 0 ...100 (low-high).
4. Once the level has been selected, press the ENTER button to set it (or, to return to the higher level of the menu structure without any change press the MENU button).

Fixture settings

Pan and/or tilt inversion

The FIXTURE SETTINGS→PAN INVERSE and TILT INVERSE menus can be used to reverse the direction of pan and/or tilt. These settings are useful for symmetrical effects with multiple fixtures, or when coordinating the movement of fixtures that are floor mounted and rigged upside down.

To adjust the pan inversion settings:

1. Select FIXTURE SETTINGS and press the ENTER button to confirm.
2. Use the DOWN and UP buttons to select PAN INVERSE or TILT INVERSE and press the ENTER button to confirm.
3. Use the DOWN and UP buttons to select the YES (inversion) or NO (normal) mode.
4. Press the ENTER button to confirm (or, to return to the higher level of the menu structure without any change press the MENU button).

Pan/tilt feedback

By default, pan/tilt feedback is enabled. This means that if a pan or tilt position error is detected, the fixture will correct the pan/tilt position.

To deactivate, or activate this function use the FIXTURE SETTINGS→P/T FEEDBACK menu.

Iris inversion

To invert the iris settings:

1. Select FIXTURE SETTINGS and press the ENTER button to confirm.

2. Use the DOWN and UP buttons to select IRIS INVERSE and press the ENTER button to confirm.
3. Use the DOWN and UP buttons to select the YES (inversion) or NO (normal) mode.
4. Press the ENTER button to confirm (or, to return to the higher level of the menu structure without any change press the MENU button).

Blackout during change or movement

The fixture can be set, so that when running a show, blackout is enabled during gobo change, color change, and/or pan and tilt movement. This is switched off by default.

To adjust the blackout during show playback settings:

1. Select FIXTURE SETTINGS and press the ENTER button to confirm.
2. Use the DOWN and UP buttons to select BL. O. P/T MOVING, BL. O. COLOR CHANGE, or BL. O: GOBO CHANGE and press the ENTER button to confirm.
3. Use the DOWN and UP buttons to select the YES (blackout during movement or change) or NO (normal) mode.
4. Press the ENTER button to confirm (or, to return to the higher level of the menu structure without any change press the MENU button).

Display settings

Invert display

Inverting the display is useful if the fixture is hung from a truss or from elevation. To invert the display:

1. Select DISPLAY SETTINGS and press the ENTER button to confirm.
2. Use the DOWN and UP buttons to select DISPLAY INVERSE and press the ENTER button to confirm.
3. Use the DOWN and UP buttons to select the YES (invert).
4. Press the ENTER button to confirm (or, to return to the higher level of the menu structure without any change press the MENU button).

Automatically turn off display backlight

By default the display is lit when the power is applied to the fixture. It can be set to automatically dim if the buttons and menus have not been used for a period:

1. Select DISPLAY SETTINGS and press the ENTER button to confirm.

2. Use the DOWN and UP buttons to select BACKLIGHT AUTO OFF and press the ENTER button to confirm.
3. Use the DOWN and UP buttons to select the YES.
4. Press the ENTER button to confirm (or, to return to the higher level of the menu structure without any change press the MENU button).

Adjust backlight brightness

The brightness of the control panel display can be adjusted:

1. Select DISPLAY SETTINGS and press the ENTER button to confirm.
2. Use the DOWN and UP buttons to select BACKLIGHT BRIGHTNESS and press the ENTER button to confirm.
3. Use the DOWN and UP buttons to set a level from 1 to 10.
4. Press the ENTER button to confirm (or, to return to the higher level of the menu structure without any change press the MENU button).

Fixture test

Automatic tests of all functions or manual test of individual functions can be run from the control menus.

Auto test

To perform a complete test of all of the fixture functions:

1. Select FIXTURE TEST and press the ENTER button to confirm.
2. Use the DOWN and UP buttons to select AUTO TEST and press the ENTER button to confirm. The automatic test will run.

Manual test

Fixture functions can be tested or controlled manually:

1. Select FIXTURE TEST and press the ENTER button to confirm.
2. Use the DOWN and UP buttons to select MANUAL TEST and press the ENTER button to confirm.
3. To return to a higher level of the menu press the MENU button again.

Fixture information

Fixture operating hours counter

To see how many hours the fixture has been used:

1. Select FIXTURE INFORMATION and press the ENTER button to confirm.

2. Use the DOWN and UP buttons to select FIXTURE USE HOUR and press the ENTER button to confirm. The number of hours will be shown.

Service countdown counter

This counter is resettable and can be used to monitor service intervals. The counter is available under the FIXTURE INFORMATION→LIGHT USE HOUR menu.

Firmware version

To see what software version is installed in the fixture:

1. Select FIXTURE INFORMATION and press the ENTER button to confirm.
2. Use the DOWN and UP buttons to select FIRMWARE VERSION and press the ENTER button to confirm. The firmware version will be shown.

Reset functions or effects

The various effects—pan, tilt color, gobos, iris, focus, prism—or all effects, can be manually reset to their home positions:

1. Select RESET FUNCTIONS and press the ENTER button to confirm.
2. Use the DOWN and UP buttons to select the function or effect that is to be reset. Press the ENTER button.
3. Use the DOWN and UP buttons to select YES and press the ENTER button to confirm (or to return to a higher level of the menu structure without any change press the MENU button).

Reset factory default settings

The fixture's default settings can be restored using SPECIAL FUNCTIONS→FACTORY SETTINGS.

Effect home position adjustment

The various effects—pan, tilt color wheels, gobo wheels, gobos, iris, focus, and prism—can lose or move out of their indexed home position. To reset any of these:

1. In the menu structure, hold the ENTER button down for at least 3 seconds to enter the OFFSET MENU.
2. Use the DOWN and UP buttons to choose the function that needs to be adjusted. Press the ENTER button to select it.
3. The present indexed home position will appear blinking in the display. Use the DOWN and UP buttons to adjust the home position of the function or effect.

- Once the correct position has been reached, press the ENTER button to set this (or to return to a higher level of the menu structure without any change press the MENU button).

Effects

This section describes DMX-controllable effects that require particular explanation. See DMX protocol on page 27 for a full list of the DMX channels and values required to control the different effects.

Pan & tilt

The fixture's moving head can be panned through 540° and tilted through 270° using coarse or fine control channels. The fixture can be set to automatic blackout during pan and tilt movement.

The fixture incorporates pan and tilt feedback, so that if a pan or tilt position error is detected, the shutter closes and the fixture resets to the correct pan & tilt position. This can be disabled if not required (see Control menus on page 31).

Gobos

The fixture contains two gobo wheels:

GOBO WHEEL 1:



GOBO WHEEL 2:

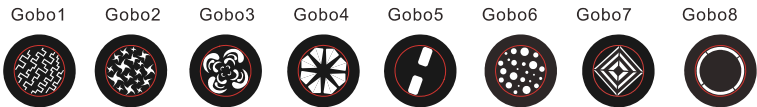

Any gobo can be projected statically. Gobos can be shaken, and the gobo wheels can be rotated clockwise or counter-clockwise. If an individual gobo on wheel 1 is selected on channel 10, it can be set to an indexed angle or rotated clockwise or counter-clockwise using channel 11. The fixture can be set to automatic blackout during gobo changes.

Iris

The fixture provides an adjustable iris, allowing the diameter of the projected beam to be adjusted.

Motorized focus

Motorized focus adjustment lets you create sharp or blurred projections to suit the effect you want to achieve.

Prism

The fixture incorporates a prism that can be inserted into the beam to give split beam effects. The prism can be set to an indexed angle or rotated clockwise or counter-clockwise.

Strobe effects

The strobe effects provide instant open and blackout, variable speed regular and random strobe.

Electronic dimming

Overall intensity can be adjusted 0-100%.

Color wheels

The fixture incorporates two color wheels, each with seven colors plus open. Slots can be individually selected, or the wheels can be rotated at varying speeds, clockwise or counter-clockwise. The fixture can be set to automatic blackout during color changes.

Maintenance



Read Safety information on page 4 before servicing the fixture.

Refer any service operation not described in this user manual to a qualified service technician.

Disconnect mains power before cleaning or servicing the fixture.

Service fixtures in an area where there is no risk of injury from failing parts, tools, etc.

The user may carry out the service operations described in this manual. All other service operations must be carried out by an authorized RUSH by Martin service technician. Do not try to repair the fixture yourself, as you may create a safety risk or cause damage that is not covered by the product warranty.

Installation, on-site service and maintenance can be provided worldwide by the Martin Professional Global Service organization and its approved agents, giving owners access to Martin's expertise and product knowledge in a partnership that will ensure the highest level of performance throughout the product's lifetime. Please contact your RUSH by Martin supplier for details.

Cleaning

Excessive dust, smoke fluid, and particle buildup degrades performance, causes overheating and will damage the fixture. Damage caused by inadequate cleaning or maintenance is not covered by the product warranty.

The cleaning of external optical lenses must be carried out periodically to optimize light output. Cleaning schedules for lighting fixtures vary greatly depending on the operating environment. It is therefore impossible to specify precise cleaning intervals for the fixture. Environmental factors that may result in a need for frequent cleaning include:

- Use of smoke or fog machines.
- High airflow rates (near air conditioning vents, for example).
- Presence of cigarette smoke.
- Airborne dust (from stage effects, building structures and fittings or the natural environment at outdoor events, for example).

If one or more of these factors is present, inspect fixtures within their first 100 hours of operation to see whether cleaning is necessary. Check again at frequent intervals. This procedure will allow you to assess cleaning

requirements in your particular situation. If in doubt, consult your RUSH by Martin dealer about a suitable maintenance schedule.

Use gentle pressure only when cleaning, and work in a clean, well-lit area. Do not use any product that contains solvents or abrasives, as these can cause surface damage.

To clean the fixture:

1. Disconnect the fixture from power and allow it to cool for at least 10 minutes.
2. Vacuum or gently blow away dust and loose particles from the outside of the fixture and the air vents at the back and sides of the head and in the base with low-pressure compressed air.
3. Clean the surfaces by wiping gently with a soft, clean lint-free cloth moistened with a weak detergent solution. Do not rub glass surfaces hard: lift particles off with a soft repeated press. Dry with a soft, clean, lint-free cloth or low-pressure compressed air. Remove stuck particles with an unscented tissue or cotton swab moistened with glass cleaner or distilled water.
4. Check that the fixture is dry before reapplying power.

Changing the primary fuse

If the fixture is completely dead, the fixture's primary fuse F1 may have blown and it may be necessary to install a new fuse. This fuse is located in a fuseholder next to the Mains OUT socket on the connections panel. See 'Fixture overview' on page 13.

If you need to replace a fuse:

1. Disconnect the fixture from power and allow it to cool for at least 10 minutes.
2. Unscrew the cap of the fuseholder and remove the fuse. Replace with a fuse of the same size and rating only.
3. Reinstall the fuseholder cap before reapplying power.

Gobo replacement

It is possible to replace the rotating gobos with custom metal gobos of the following size:

- Gobo diameter: 26.8 mm (1.1 in.)
- Gobo image diameter: 22 mm (0.87 in.)

Custom gobos must meet the same quality standards as the gobos supplied in the product.







Optical components are fragile and are exposed to high temperatures. Wear cotton gloves while handling them and keep them perfectly clean to reduce the risk of heat damage. Do not contaminate them with grease or oil, from your fingers for example. Handle and store them with care.









To replace a gobo:

1. Disconnect the fixture from power and allow it to cool for at least 10 minutes.
2. Remove the fixture head cover using a Phillips screwdriver.
3. The rotating gobos sit in blades that slot into the rotating gobo wheel. Lift out the blade that contains the gobo that is to be replaced.
4. The gobo is held in place on the blade by a wire clip. Remove the clip, replace the gobo, replace the wire clip and replace the blade in the rotating gobo wheel.
5. Reinstall the head cover and be ready for the head to move during a reset before reapplying power.

DMX protocol

Chan.	Value	Function
1	1-255	Pan 0°-540°
2	1-255	Pan (fine control)
3	1-255	Tilt 0°-270°
4	1-255	Tilt (fine control)
5	1-254	Pan/tilt speed, fast- slow
	255	Pan/tilt speed, fast
6	0-255	Dimmer 0-100%
7	Strobe	
	0-7	Off
	8-15	Open
	16-131	Strobe, slow-fast
	132-139	Open
	140-181	Fast close, slow open
	182-189	Open
	190-231	Slow close, fast open
	232-239	Open
	240-247	Random strobe
8	Color wheel 1	
	0-7	Color 1 – Open
	8-15	Color 2 – Light Blue
	16-23	Color 3 – Green
	24-31	Color 4 – Orange
	32-39	Color 5 – Yellow
	40-47	Color 6 – Magenta
	48-55	Color 7 – Dark blue
	56-63	Color 8 – Red
	64-127	Indexing
	128-189	Clockwise, fast-slow
	190-193	Stop
	194-255	Counter-clockwise, slow-fast
9	Color wheel 2	
	0-7	Color 1 – Open
	8-15	Color 2 – Pink
	16-23	Color 3 – CTO 3200 K
	24-31	Color 4 – Purple
	32-39	Color 5 – Yellow
	40-47	Color 6 – Green

Chan.	Value	Function
	48-55	Color 7 – CTO 5600 K
	56-63	Color 8 –Blue
	64-127	Indexing
	128-189	Clockwise, fast-slow
	190-193	Stop
	194-255	Counter-clockwise, slow-fast
10	Gobo wheel 1 (rotating gobos)	
	<div style="display: flex; justify-content: space-around; text-align: center;"> <div>Gobo1 </div> <div>Gobo2 </div> <div>Gobo3 </div> <div>Gobo4 </div> <div>Gobo5 </div> <div>Gobo6 </div> <div>Gobo7 </div> </div>	
	0-7	Open
	8-15	Gobo 1
	16-23	Gobo 2
	24-31	Gobo 3
	32-39	Gobo 4
	40-47	Gobo 5
	48-55	Gobo 6
	56-63	Gobo 7
	64-73	Gobo 1 shake
	74-82	Gobo 2 shake
	83-91	Gobo 3 shake
	92-100	Gobo 4 shake
	101-109	Gobo 5 shake
	110-118	Gobo 6 shake
	119-127	Gobo 7 shake
	128-189	Wheel rotation, clockwise, fast-slow
	190-193	Stop
	194-255	Wheel rotation, counter clockwise, slow-fast
11	Gobo rotation (wheel 1)	
	0-127	Indexed position, 0°-360°
	128-189	Clockwise rotation, fast-slow
	190-193	Stop
	194-255	Counter-clockwise rotation, slow-fast

Chan.	Value	Function						
12	Gobo wheel 2 (fixed gobos)							
	Gobo1	Gobo2	Gobo3	Gobo4	Gobo5	Gobo6	Gobo7	Gobo8
								
		0-7	Open					
		8-14	Gobo 1					
		15-21	Gobo 2					
		22-28	Gobo 3					
		29-35	Gobo 4					
		36-42	Gobo 5					
		43-49	Gobo 6					
		50-56	Gobo 7					
		57-63	Gobo 8					
		64-71	Gobo 1 shake					
		72-79	Gobo 2 shake					
		80-87	Gobo 3 shake					
		88-95	Gobo 4 shake					
		96-103	Gobo 5 shake					
		104-111	Gobo 6 shake					
		112-119	Gobo 7 shake					
		120-127	Gobo 8 shake					
	128-189	Wheel rotation, counter clockwise, fast-slow						
	190-193	Stop						
	194-255	Wheel rotation 2, clockwise, slow-fast						
13	Prism							
	0-127	No effect						
	128-255	Prism effect						
14	Prism rotation							
	0-127	Indexed position 0°-360°						
	128-189	Clockwise rotation, fast-slow						
	190-193	Stop						
	194-255	Counter-clockwise rotation, slow-fast						
15	0-255	Iris, maximum-minimum						
16	0-255	Focus, close-distant						
17	Settings and fixture control							
	0-69	No function						
	70-79	Blackout during pan & tilt						
	80-89	Disable blackout during pan & tilt						

Chan.	Value	Function
	90-99	Blackout during color change
	100-109	Disable blackout during color change
	110-119	Blackout during gobo change
	120-129	Disable blackout during gobo change
	130-139	No function
	140-149	Pan/tilt reset
	150-159	Color reset
	160-169	Gobo reset
	170-179	No function
	180-189	Focus reset
	190-199	No function
	200-209	Reset all
	210-219	Blackout during pan/tilt or color/gobo change
	220-229	Disable blackout during pan/tilt or color/gobo change
	230-255	No function

Control menus

To access the control menus, press the MENU button. Use the UP and DOWN buttons to navigate the menus. Select any required menu option using the ENTER button. For more information, see Using the control menus on page 15.

Default fixture settings are shown in **bold**.

Menu	Sub-menu	Setting/value	Explanation
DMX Functions	DMX Address	1–512	Fixture DMX address setting
	Mode	17 channel	
	View DMX Value	View values received on DMX channels	
Show settings	Offline Mode	M/S	When no DMX signal, go to Show Mode
		Hold	When no DMX signal, do nothing (hold)
		Blackout	When no DMX signal, black out
	Show Mode	Show 1	Pre-programmed show 1
		Show 2	Pre-programmed show 2
		Show 3	Pre-programmed show 3
		Show 4	Pre-programmed show 4
	Focus 1	0-255	Focus setting for gobo wheel 1 (rotating gobos)
	Focus 2	0-255	Focus setting for gobo wheel 2 (fixed gobos)
	Sound Trigger	Off	Sound activation off
		On	Sound activation on
	Sound Sensitivity	0-100	Sound activation microphone sensitivity (low-high)

Fixture settings	Pan Inverse	Yes/ No	Inverse pan direction
	Tilt Inverse	Yes/ No	Invert tilt direction
	P/T Feedback	Yes/ No	If pan or tilt position error is detected, fixture corrects pan/tilt position
	Iris Inverse	Yes/ No	Invert iris action
	Bl.O. P/T Moving	Yes/ No	Blackout during pan/tilt movement
	Bl.O. Color Change	Yes/ No	Blackout during color change
	Bl.O. Gobo Change	Yes/ No	Blackout during gobo change
Display settings	Display inverse	Yes/ No	Invert control panel display
	Backlight Auto Off	Yes/ No	Automatically turn off display backlight when not in use.
	Backlight Brightness	1-10	Display panel backlight brightness
	Temperature Unit	°C/°F	Celsius / Fahrenheit
Fixture Test	Auto Test		Automatic test of all functions
	Manual Test		Manually test all functions
Fixture Information	Fixture Use Hour		Fixture operating hour counter (non-resettable)
	Light Use Hour	Exit	Exit without resetting time
		Reset Time	Reset service countdown timer
	Firmware Version		Currently installed firmware version
Reset Functions	Pan & Tilt	Yes/ No	
	Color	Yes/ No	
	Gobo	Yes/ No	
	Prism	Yes/ No	
	Iris	Yes/ No	
	Focus	Yes/ No	
	All	Yes/ No	

Special Functions	Factory Settings	Yes/No	Return all settings to factory defaults
-------------------	------------------	--------	---

The Offset menu is used to adjust the home position of the various effects.

To access the Offset menu, press the MENU button to enter the menu structure and then press and hold the ENTER button for three seconds.

Menu	Sub-menu	Setting	Explanation
Offset	Pan	-128...127	
	Tilt	-128...127	
	Color 1	-128...127	
	Color 2	-128...127	
	Gobo 1	-128...127	Wheel with rotating gobos
	R Gobo 1	-128...127	Rotating gobos
	Gobo 2	-128...127	Wheel with fixed gobos
	Iris	0-255	
	Prism	0-255	
	R prism	-128...127	
	Focus	0-255	

Error messages

Error:	Appears when:
Lamp Startup Fail	No LEDs sensed, possible wiring damage.
Temperature Sense Error	Damage to temperature sensor on PCB reported.
Lamp Too Hot Power Off	Internal temperature higher than 110° C detected. Ensure that fixture is adequately ventilated. Check that ambient temperature does not exceed 40° C. Possible fan or temperature sensor damage. Contact Martin support.
Lamp Too Hot Low Power	Internal temperature higher than 105° C detected. Fixture runs at reduced power level.
Maintenance Fixture	Service countdown timer has reached zero. Check whether fixture requires maintenance such as cleaning, then reset countdown timer in Fixture Information menu.
Memory Initial Fail	Damaged memory IC. Contact Martin support.
CPU-B Error, CPU-C Error, CPU-D Error	Board, processor or fixture wiring is damaged. Contact Martin support.
Pan Reset Error Pan Encode Error Tilt Reset Error Tilt Encode Error Shutter Reset Fail Dimmer Reset Fail Color Reset Fail Gobo Reset Fail	These can appear when powering on or resetting the fixture and can indicate damage to sensors or components. If error persists, contact Martin support.

Troubleshooting

This section describes a few common problems that may occur during operation and provides some suggestions for easy troubleshooting:

Symptom	Potential cause	Remedies
No light from fixture, or fans not working.	Power supply issue, such as blown fuse, faulty connector or damaged cable.	Check whether fixture's power indicator LED is lit. Check all power connections and cables. Replace fixture fuse.
Fixture does not react to music beat.	Sound activation disabled. Sound activation sensitivity too low for music source.	Ensure that fixture is not connected to a DMX signal. Adjust sound activation microphone sensitivity. Tap microphone to check correct functionality. The fixture should react when in sound activation mode.
One of the control channels is unresponsive or only responds intermittently.	DMX setup or DMX link fault. Damaged step motor or cable connection between head and body.	See next section. Contact your RUSH by Martin authorized distributor or service center for assistance.

Symptom	Potential cause	Remedies
<p>Fixture does not respond to DMX control.</p>	<p>Incorrect DMX addressing.</p> <p>Fault on DMX link due to damaged connector or cable, or potential interference from proximity to a high-voltage installation.</p>	<p>Ensure that fixture's DMX address matches address set on DMX control device.</p> <p>Check that fixture DMX LED is on, and if not, check all DMX cables and connections.</p> <p>Ensure that DMX link is terminated.</p> <p>Check that all components on DMX link use standard DMX polarity.</p> <p>Attempt to control the fixture with another DMX control device.</p> <p>Move or shield link if it is close to an unshielded high-voltage installation.</p>

Specifications

Physical

Weight 18 kg (39.7 lbs.)
 Dimensions 418 x 588 x 328 mm (16.5 x 23.1 x 12.9 in.)

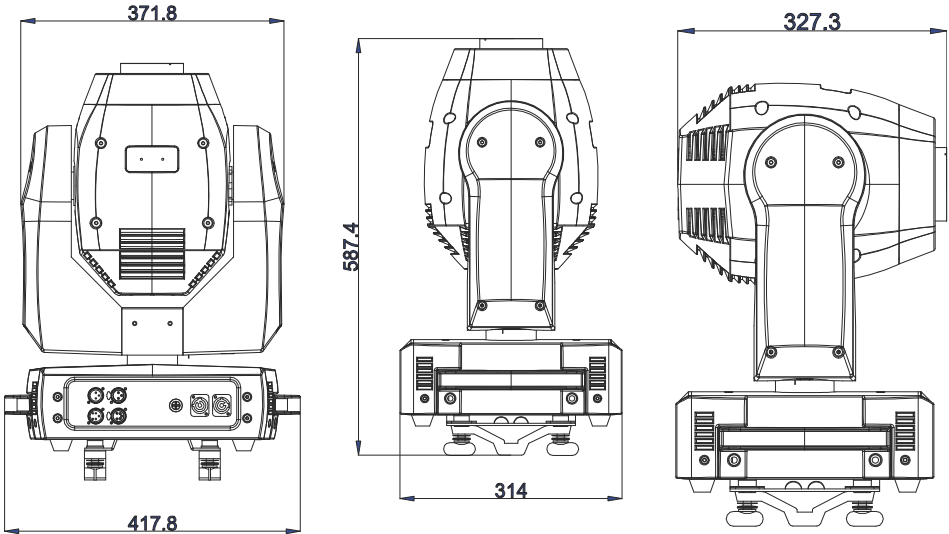

Dynamic Effects

Color wheel 1 7 colors plus open, rotation with
 variable direction and speed
 Color wheel 2 7 colors (incl. 1 x UV, 2 x CTC) plus open,
 rotation with variable direction and speed

GOBO WHEEL 1:



GOBO WHEEL 2:



Rotating gobo wheel 7 gobos plus open, wheel rotation,
 gobo indexing, rotation and shake

Static gobo wheel.....	8 gobos plus open, wheel rotation and shake
Electronic 'shutter' effect.....	Strobe effect, pulse effects, instant open and blackout
Prism.....	Indexing and rotation with variable direction and speed
Iris.....	Motorized
Focus.....	Motorized
Electronic dimming.....	0 - 100%, four dimming curve options
Pan.....	.540°, coarse & fine control and speed
Tilt.....	.270°, coarse & fine control and speed

Control and Programming

Control options.....	DMX, stand-alone
DMX channels.....	17
Stand-alone trigger options.....	Music trig, auto trig
Stand-alone sequences.....	4 pre-programmed shows
Stand-alone memory.....	20 scenes
Music trig sensitivity.....	Adjustable
Setting and addressing.....	Control panel with backlit LCD display
DMX compliance.....	USITT DMX512/1990

Optics and Photometric Data

Light source.....	180 W LED engine
Minimum LED lifetime.....	50 000 hours (to >70% luminous output)*
Rotating gobo size.....	26.8 mm (1.1 in.)
Rotating gobo image size.....	22 mm (0.87 in.)

**Figure obtained under manufacturer's test conditions*

Construction

Color.....	Black
Housing.....	High-impact flame-retardant thermoplastic
Protection rating.....	IP 20

Installation

Mounting points.....	Two quarter-turn brackets for rigging clamps
Location.....	Indoor use only, must be fastened to surface or structure
Orientation.....	Any

Connections

AC power input.....	Neutrik PowerCon
AC power throughput.....	Neutrik PowerCon
DMX data in/out.....	3-pin & 5-pin locking XLR

Electrical

AC power	100-240 V nominal, 50/60 Hz
Power consumption	350 W
Fuse	T 6.3 A
Power supply unit.....	Auto-ranging electronic switch mode

Typical Power and Current

100 V, 60 Hz	3.2 A, 320 W
230 V, 50 Hz	1.5 A, 306 W

Measurements made at nominal voltage with all LEDs at full intensity. Allow for a deviation of +/- 10%.

Thermal

Cooling	Forced air
Maximum ambient temperature (T _a max.)	40° C (104° F)
Minimum ambient temperature (T _a min)	0°C (32° F)
Total heat dissipation*	1010 BTU/hr.

**Calculated, +/- 10%, at full intensity, full white*

Included Items

Power cable, 6 A, 18 AWG, 0.75 mm², UL- listed, H05VV-F, 1.5 m, without mains plug

Accessories

Cables, 16 A, for connection to power in chains, US/Canada

Power input cable, 12 AWG, SJT, with PowerCon input connector, 3 m (9.8 ft.)	P/N 11541503
Power relay cable, 12 AWG, SJT, with PowerCon connectors, 1.4 m (4.6 ft.)	P/N 11850099
Power relay cable, 12 AWG, SJT, with PowerCon connectors, 2.25 m (7.4 ft.)	P/N 11850100
Power relay cable, 12 AWG, SJT, with PowerCon connectors, 3.25 m (10.7 ft.)	P/N 11850101

Cables, 16 A, for connection to power in chains, EU

Power input cable, 2.5 mm ² , H05VV-F, with PowerCon input connector, 3 m (9.8 ft.)	P/N 11541007
Power relay cable, 2.5 mm ² , H05VV-F, with PowerCon connectors, 1.4 m (4.6 ft.)	P/N 11541008
Power relay cable, 2.5 mm ² , H05VV-F, with PowerCon connectors, 2.25 m (7.4 ft.)	P/N 11541009
Power relay cable, 2.5 mm ² , H05VV-F, with PowerCon connectors, 3.25 m (10.7 ft.)	P/N 11541010

Power connectors

- Neutrik PowerCon NAC3FCA
power input connector, cable mount, blue P/N 05342804
- Neutrik PowerCon NAC3FCB
power output connector, cable mount, light grey P/N 05342805

Installation hardware

- Half-coupler clamp P/N 91602005
- G-clamp (suspension vertically downwards only)..... P/N 91602003
- Quick-trigger clamp (suspension vertically downwards only).... P/N 91602007
- Safety wire, safe working load 50 kg P/N 91604003

Related Items

- RUSH Software Uploader 1™ P/N 91611399

Ordering Information

- RUSH MH 1 Profile™ in cardboard box P/N 90280000

Specifications are subject to change without notice. For the latest product specifications, see www.martin.com

	<p>Disposing of this product</p> <p>RUSH by Martin™ products are supplied in compliance with Directive 2012/19/EC of the European Parliament and of the Council of the European Union on WEEE (Waste Electrical and Electronic Equipment), where applicable. Help preserve the environment! Ensure that this product is recycled at the end of its life. Your supplier can give details of local arrangements for the disposal of RUSH by Martin products.</p>
--	---



Innovation • Quality • Performance