

Active Transmitter Combiner 8:1 AC 3200-II



Instruction manual

 **SENNHEISER**

Contents

- Important safety instructions 2
- The AC 3200-II active transmitter combiner 8:1 4
- Delivery includes 4
- Connection diagram 5
- Product overview 6
- Putting the AC 3200-II into operation 7
 - Preparing the AC 3200-II for use 7
 - Connecting devices 9
 - Connecting a transmitter to the AC 3200-II 10
 - Connecting the mains unit 10
 - Switching the AC 3200-II on and off 11
- Recommendations and tips for optimum transmission 11
- Cleaning and maintaining the AC 3200-II 12
- If a problem occurs 12
- Specifications 14
- Manufacturer Declarations 15

Important safety instructions

1. Read these instructions.
2. Keep these instructions. Always include these instructions when passing the device on to third parties.
3. Heed all warnings.
4. Follow all instructions.
5. Do not use the device near water.
6. Clean only with a dry cloth.
7. Do not block any ventilation openings. Install in accordance with these instructions.
8. Do not install near any heat sources such as radiators, heat registers, stoves, or other devices (including amplifiers) that produce heat.
9. The device should be operated only from the type of power source indicated in the chapter "Specifications" (see page 14) and on the mains unit. The device must only be connected to properly grounded power outlets.
10. Protect the mains cable from being walked on or pinched, particularly at plugs, convenience receptacles, and the point where it exits from the device.
11. Only use attachments/accessories specified by Sennheiser.
12. Use only with the cart, stand, tripod, bracket, or table specified by the manufacturer, or sold with the device.
When a cart is used, use caution when moving the cart/apparatus combination to avoid injury from tip-over.
13. Unplug the device during lightning storms or when unused for long periods of time.
14. Refer all servicing to qualified service personnel. Servicing is required if the device has been damaged in any way, such as mains cable or plug damage, liquid has been spilled, objects have fallen inside, the device has been exposed to rain or moisture, does not operate properly or has been dropped.
15. To completely disconnect the device from the AC mains, disconnect the mains plug from the AC receptacle.



16. WARNING: To reduce the risk of fire or electric shock, do not expose the device to rain or moisture.



17. Do not expose the device to dripping or splashing and ensure that no objects filled with liquids, such as vases or coffee cups, are placed on the device.

18. The plug of the mains cable shall remain readily accessible.

Intended use

Intended use of the AC 3200-II includes:

- using the device for professional purposes,
- having read this instruction manual especially the chapter "Important safety instructions" on page 2,
- using the device within the operating conditions and limitations described in this instruction manual.

"Improper use" means using the device other than as described in this instruction manual, or under operating conditions which differ from those described herein.

This instruction manual is also available on the Internet at www.sennheiser.com.



The AC 3200-II active transmitter combiner 8:1

With the AC 3200-II active transmitter combiner, the signals of up to eight Sennheiser wireless monitoring transmitters can be combined onto a single antenna, e.g. the A 2003 UHF directional antenna, the A 1031 U omni-directional antenna or the A 5000 CP circularly polarized UHF antenna. For suitable transmitters, please refer to the AC 3200-II product page at www.sennheiser.com.

The AC 3200-II allows you to make high-quality 8-channel transmission systems suitable for the following areas of application:

- Multi-channel monitoring systems for stage use
- Multi-channel systems suitable for any application where talk-back signals are to be transmitted (e.g. studio)

Delivery includes

- 1 AC 3200-II active transmitter combiner 8:1
- 1 NT12-125D mains unit
- 3 mains cables (EU/UK/US)
- 4 self-adhesive device feet
- 1 instruction manual

Connection diagram

The below connection diagram shows the connections for an 8-channel system with a single antenna.

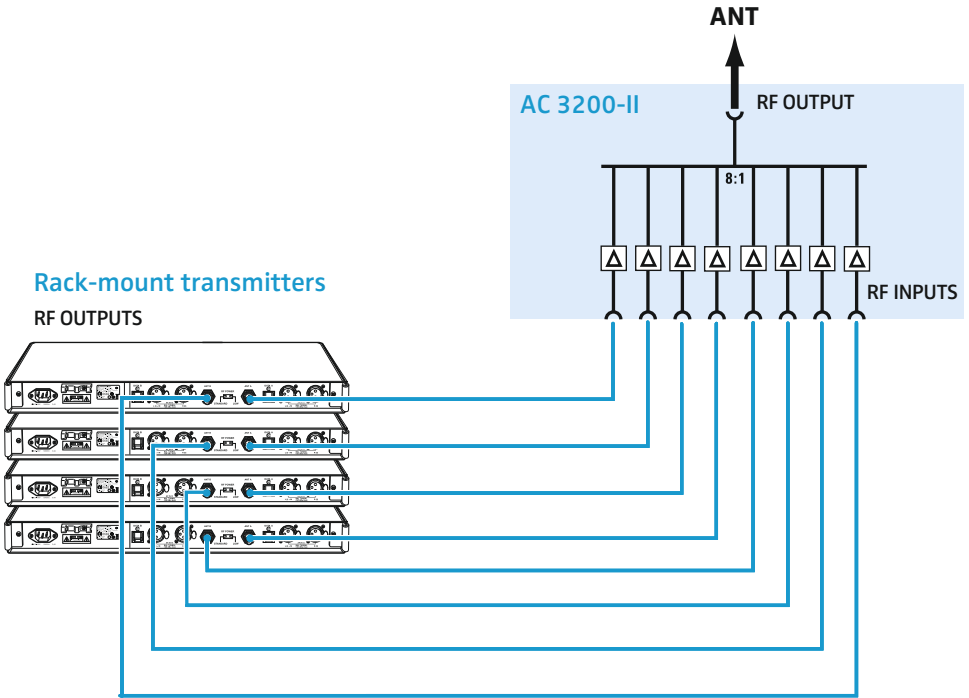

Product overview

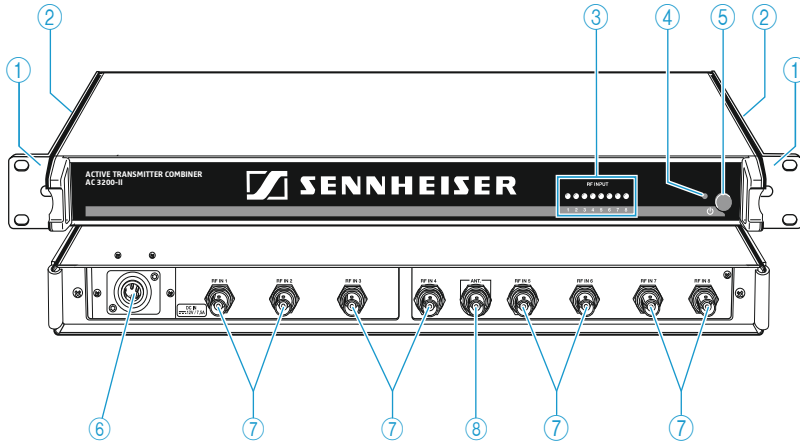

- ① Rack mount "ears"
- ② Air vents (on the sides)
- ③ 8 LEDs: operation indicators of the RF inputs
- ④ LED \char"26
- ⑤ On/off switch \char"26
- ⑥ DC input socket for connecting the NT 12-125D mains unit
- ⑦ 8 RF inputs **RF IN 1** to **RF IN 8** for connecting the transmitters
- ⑧ BNC socket for antenna output **ANT**

Putting the AC 3200-II into operation

Preparing the AC 3200-II for use

You can set up the AC 3200-II on an even surface or mount it into a rack.

Setting up the device

CAUTION

Danger of heat damage to the devices

During operation, the AC 3200-II and the connected transmitters produce considerable waste heat. If this heat cannot dissipate, it can cause damage to the devices.

The devices are equipped with fans to assist dissipation of generated heat:

- ▶ Make sure that the air vents ② on the sides of the AC 3200-II are not covered or blocked and provide ducts of sufficient size or allow sufficient space to ensure a free air flow between the devices.
 - ▶ Regularly clean the air vents on the sides of the AC 3200-II with a soft brush.
 - ▶ In order to avoid heat accumulation, make sure to install the AC 3200-II as the uppermost device.
 - ▶ Never stack more than two devices directly one above the other.
 - ▶ Never place several NT 12-125D mains units directly next to one another.
-

To ensure that the AC 3200-II cannot slip on the surface on which it is placed, four self-adhesive soft rubber feet are supplied.

CAUTION

Risk of staining of surfaces

Some surfaces have been treated with varnish, polish or synthetics which might cause stains when they come into contact with other synthetics. Despite a thorough testing of the synthetics used by us, we cannot rule out the possibility of staining.

- ▶ Do not place the AC 3200-II on delicate surfaces.
-
- ▶ Ensure that the base of the AC 3200-II is clean and free from grease before fitting the rubber feet.

- ▶ Fix the rubber feet to the base of the AC 3200-II by peeling off the backing paper and fitting them as shown in the diagram on the right.
- ▶ Place the AC 3200-II on an even, horizontal surface.

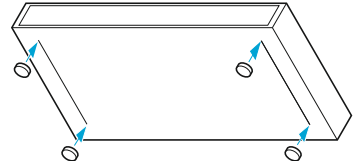

Rack-mounting



CAUTION

Risks when rack mounting the AC 3200-II

When installing the device in a closed or multi-rack assembly, please consider that, during operation, the ambient temperature, the mechanical loading and the electrical potentials will be different from those of devices which are not mounted into a rack:

- ▶ The ambient temperature within the rack must not exceed the temperature limit specified in the AC 3200-II specifications.
- ▶ When installing the device in a rack, take good care not to affect the ventilation required for safe operation. If necessary, provide additional ventilation.
- ▶ In order to avoid heat accumulation, make sure to install the AC 3200-II as the uppermost device in the rack.
- ▶ Provide for a duct or vent space of 1 U above the AC 3200-II to ensure that the heated air can dissipate.
- ▶ Never place several NT 12-125D mains units directly next to one another.
- ▶ Make sure the mechanical loading of the rack is even to avoid a hazardous condition such as a severely unbalanced rack.
- ▶ Make sure the two cables of the NT 12-125D mains unit are not exposed to mechanical loading (e.g. pulling).
- ▶ When connecting the device to the power supply, observe the information indicated on the mains unit. Avoid circuit overloading. If necessary, provide overcurrent protection.
- ▶ Ensure a reliable mains ground connection of the device by taking appropriate measures – especially when you are using multi-outlet power strips or extension cables.

To mount the AC 3200-II into a 19" rack:

- ▶ Slide the AC 3200-II into the 19" rack.
- ▶ Secure the rack mount "ears" ① to the rack using four screws (to be ordered separately).

Connecting devices

Connecting the antenna

CAUTION

Danger of damage to the devices!

Do **not** daisy-chain several AC 3200-II. Do **not** connect other active combiners to the AC 3200-II.

- ▶ Never connect the AC 3200-II to other active combiners.
 - ▶ Only connect suitable antennas to the output of the AC 3200-II.
-

The AC 3200-II active transmitter combiner can be used with either the A 2003 UHF directional antenna, the A 1031 U omni-directional antenna or the A 5000 CP circularly polarized UHF antenna. The antenna transmits the signals of all connected transmitters (see page 11).

The signals are combined onto the antenna output with no distribution attenuation.

To connect an antenna:

- ▶ Connect the antenna using a low-attenuation 50-Ω coaxial cable.
- ▶ Connect the coaxial cable to the antenna output ⑧.

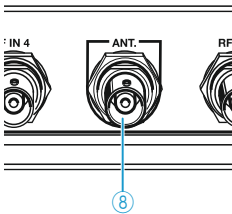

Connecting a transmitter to the AC 3200-II

To connect a transmitter:

- ▶ Connect the BNC cable of the transmitter to one of the eight RF inputs **RF IN 1** to **RF IN 8** ⑦.

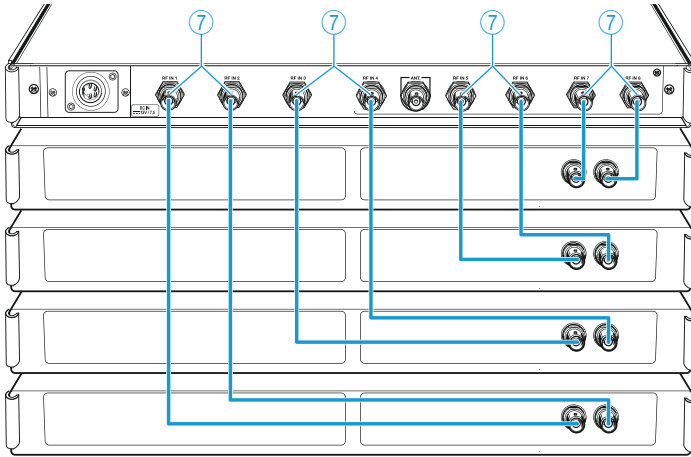



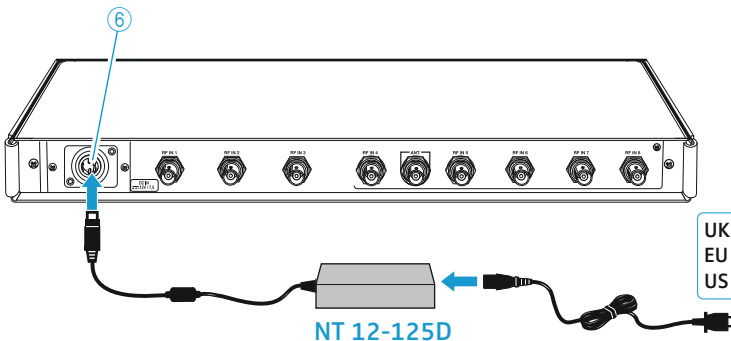

Connecting the mains unit

- ▶ Connect the mains cable (EU, UK or US version, depending on your location) to the input socket on the NT 12-125D mains unit.
- ▶ Connect the DC connector of the mains unit to the DC input socket ⑥ of the AC 3200-II.
- ▶ Connect the mains connector of the mains cable to the mains power supply.



Switching the AC 3200-II on and off

- ▶ Press the on/off switch  ⑤.
The AC 3200-II switches on and the LED  ④ lights up red.
- ▶ Press the on/off switch  ⑤ again.
The AC 3200-II switches off and the LED  ④ goes off.

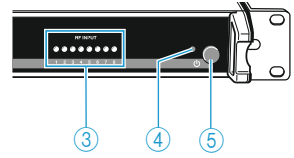

 After switch-off, the AC 3200-II is in standby mode. To disconnect the device and the NT 12-125D mains unit from the mains power supply, pull out the mains connector from the wall socket.

RF indicators

The AC 3200-II has 8 control LEDs  ③ which light up green on the channels where transmission power is available.

Recommendations and tips for optimum transmission

- There should be a “free line of sight” between transmitting and receiving antennas.
- To avoid overloading the receiver, observe a minimum distance of 5 m between transmitting and receiving antennas.
- Observe a minimum distance of 50 cm between the transmitting antenna and metal objects (such as cross members or reinforced-concrete walls).
- When using a multi-channel system:
Set all transmitters of your multi-channel system to intermodulation-free frequencies.

Cleaning and maintaining the AC 3200-II



CAUTION



Liquids can damage the electronics of the device

Liquids entering the housing of the device can cause a short-circuit and damage the electronics.

- ▶ Keep all liquids away from the device.
- ▶ Do not use any solvents or cleansing agents.

-
- ▶ Before cleaning, disconnect the NT 12-125D mains unit from the mains power supply.
 - ▶ Only use a dry cloth to clean the device.
 - ▶ Regularly check the air vents for dust deposits. If necessary, remove the dust with a soft brush.

If a problem occurs ...

Problem	Possible cause	Solution
The LED  ④ does not light up	The AC 3200-II doesn't consume current.	Check if the AC 3200-II is connected to the NT 12-125D mains unit, if the mains unit is connected to the mains power supply and if the on/off switch  ⑤ is pressed.
Extra LEDs ③ light up for RF inputs which are not in use	The transmitting antenna or the antenna cable is not connected, of the wrong type, damaged or faulty.	<p>Check that the transmitting antenna or the antenna cable is correctly connected, of the correct type, and is not damaged or faulty.</p> <p>Check that the transmitting antenna or the antenna cable is connected to the antenna output ⑧ and that all transmitters are connected to RF inputs ⑦.</p>

Problem	Possible cause	Solution
One or several LEDs ③ do not light up	A transmitter is connected to the corresponding input but the transmitter is not switched on.	Switch the transmitter on.
Disturbed reception or no reception	The transmitting antenna is not within the reception area.	Reduce the distance between transmitter and receiver.
	The receiver batteries are not inserted or batteries are low.	Replace the receiver batteries.
	The antenna is not connected correctly.	Check if the antenna is connected correctly.
	Too high cable attenuation due to too long antenna cables or wrong type of antenna cable.	Use a shorter antenna cable or the correct type of antenna cable.
		Use low-attenuation 50 Ω coaxial cable.
Interference or intermodulation during multi-channel operation.	Set all transmitters of your multi-channel system to intermodulation-free frequencies.	

If a problem occurs that is not listed in the above table or if the problem cannot be solved with the proposed solutions, please contact your local Sennheiser partner for assistance.

To find a Sennheiser partner in your country, search at www.sennheiser.com under "Service & Support".

Specifications

AC 3200-II

Frequency range	500 to 870 MHz
Distribution attenuation	0 dB (± 1 dB)
RF input power	
Nominal value	up to 100 mW per input
Inputs protected up to	max. 250 mW
Impedance	50 Ω
Power supply	12 V ---
Current consumption	max. 7.5 A
Power consumption	max. 90 W
Temperature range	-10°C to $+45^{\circ}\text{C}$
Weight	approx. 4 kg
Dimensions	436 x 215 x 44 mm

NT 12-125D

Type	Mean Well GTS160A12
Input voltage	100 to 240 V \sim
Input frequency	50 to 60 Hz
Current consumption	max. 1.85 A
Output voltage	12 V ---
Output current	max. 11.5 A
Temperature range	0°C to $+45^{\circ}\text{C}$
Weight	approx. 660 g (without mains cable)
Dimensions	175 x 72 x 35 mm
Length of DC output cable	approx. 100 cm/39 inch

In compliance with

Europe



EMC	EN 301489-1/-9
Radio	EN 300422-1/-2 EN 300454-1/-2
Safety	EN 60950

Approved by

Canada

Industry Canada RSS-123
IC: 2099A-AC3200A2
limited to 698 MHz

USA

FCC-Part 74
FCC ID: DMOAC3200A2
limited to 698 MHz

Manufacturer Declarations

Warranty

Sennheiser electronic GmbH & Co. KG gives a warranty of 24 months on this product.

For the current warranty conditions, please visit our website at www.sennheiser.com or contact your Sennheiser partner.

CE Declaration of Conformity

- **CE 0682**
- R&TTE Directive (1999/5/EC)
- RoHS Directive (2012/65/EC)

The declaration is available on the Internet at www.sennheiser.com/download.

Before putting the device into operation, please observe the respective country-specific regulations.

Statements regarding FCC and Industry Canada

This device complies with Part 15 of the FCC Rules and with Industry Canada licence-exempt RSS standard(s). Operation is subject to the following two conditions: (1) this device may not cause harmful interference, and (2) this device must accept any interference received, including interference that may cause undesired operation.

This equipment has been tested and found to comply with the limits for a Class B digital device, pursuant to Part 15 of the FCC Rules. These limits are designed to provide reasonable protection against harmful interference in a residential installation. This equipment generates, uses and can radiate radio frequency energy and, if not installed and used in accordance with the instructions, may cause harmful interference to radio communications. However, there is no guarantee that interference will not occur in a particular installation. If this equipment does cause harmful interference to radio or television reception, which can be determined by turning the equipment off and on, the user is encouraged to try to correct the interference by one or more of the following measures:

- Reorient or relocate the receiving antenna.
- Increase the separation between the equipment and receiver.
- Connect the equipment into an outlet on a circuit different from that to which the receiver is connected.
- Consult the dealer or an experienced radio/TV technician for help.

Changes or modifications made to this equipment not expressly approved by Sennheiser electronic Corp. may void the FCC authorization to operate this equipment. Before putting the device into operation, please observe the respective country-specific regulations!

Sennheiser electronic GmbH & Co. KG

Am Labor 1, 30900 Wedemark, Germany
www.sennheiser.com

Publ. 09/16, 538976/A02

